

RESISTORS APPLICATION NOTE

Medical Resistors



Resistors For Medical Applications

The electronic content of devices for medical applications continues to rise steadily as medical science develops new techniques and electronic engineering supplies new solutions. At the same time, these devices are leaving the confines of hospitals and serving the growing community-based and home-based healthcare markets.

Much of the development is based on the increasing computing power of digital systems. However, the human body remains analogue, and there will always be an important role for high reliability passive components in three broad areas:

- CONTACT
- IMAGE
- ANALYSIS

The first area, CONTACT, includes all devices with electrical connection to the body. Examples include the delivery of high energy pulses for defibrillation, the detection of biologically generated signals for ECG or EEG and the measurement of body impedance for respiratory or plethysmographic monitoring.

The IMAGE area encompasses X-ray, MRI and ultrasound, all with their own special demands on resistive components. Finally, ANALYSIS covers the area of IVD and laboratory instruments.

This application note aims to guide the designer in selecting the optimum components for all these areas. It should be read in conjunction with the full product data sheets.



- High-voltage compact solutions for defibrillator charge control
- Pulse withstanding resistors for defibrillation pulse protection
- High ohmic value parts for high gain amplifiers in ECG and similar monitors
- Ultra high-voltage resistors for X-ray head supply dividers
- Thin-film termination networks for ultrasound transducers
- Non-magnetic resistors for MRI scanners
- Precision resistors for high stability in IVD analysis equipment

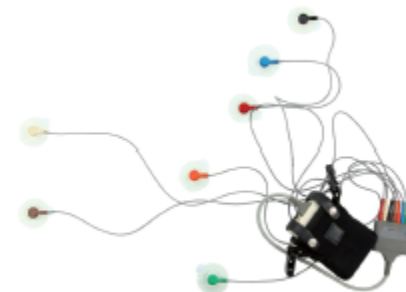

For our full product portfolio, in-house & local design support / distribution partners, visit:
<https://www.ttelectronics.com/products/categories/passive-components/>

General Note

TT Electronics reserves the right to make changes in product specification without notice or liability. All information is subject to TT Electronics' own data and is considered accurate at time of going to print.

Contact: Defibrillator Charge Control

A simplified schematic of a defibrillator charge circuit is shown in Figure 1. The stable and repeatable measurement of the charging voltage is a critical function of this circuit, as this determines the amount of electrical energy delivered to the patient. As the energy delivered is proportional to the square of the voltage, a 1% tolerance requirement for the energy will demand a 0.5% tolerance on the voltage control.

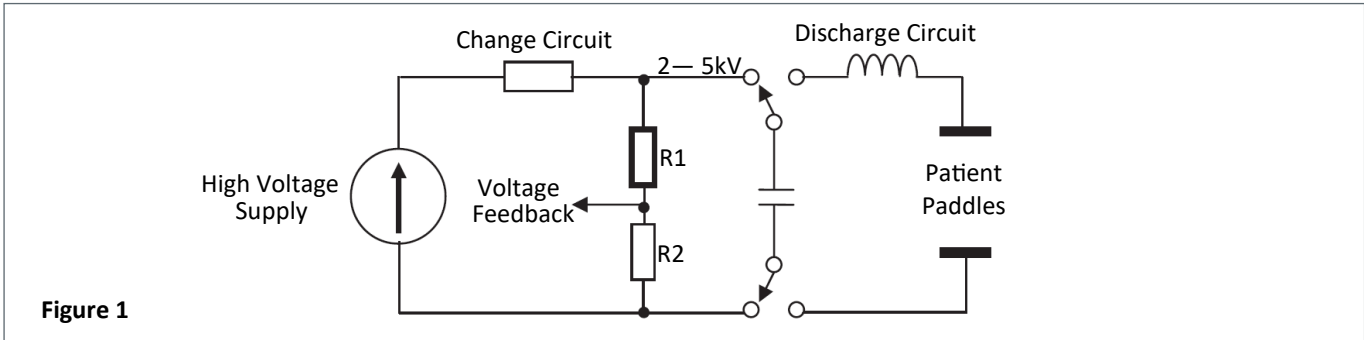

Figure 1

In this circuit R1 is a high value resistor, normally in the range 5M to 50M, which, together with a commodity chip resistor R2, forms a potential divider for voltage feedback.

The critical features of this high voltage resistor are linearity, expressed by voltage coefficient (VCR) and temperature coefficient (TCR), and long term stability under voltage stress. In addition to this, the rapid growth in the non-professional AED segment adds the requirement for compact footprint and suitability for a wider range of environmental conditions, including high humidity. The error budget for resistance value can be expressed as:

$$\text{Error} = \text{Tolerance} + \text{Solder heat stability} + \text{TCR error at } T_{\text{min}} / T_{\text{max}} + \text{VCR error at } V_{\text{max}} + \text{Environmental Stability}$$

The first two terms are commonly eliminated by post-assembly calibration. The remaining three are described in detail below.

The resistor technology best suited to this application is thick-film. The linearity limits are expressed as the temperature and voltage

coefficients of resistance, which are limits on the reversible resistance changes illustrated in Figure 2. The temperature characteristic is normally “U” shaped with limits expressed by the TCR, which is typically $\pm 100\text{ppm}/^\circ\text{C}$. The TCR error may be minimized by choosing the highest possible ohmic value so as to reduce the self heating, and by a layout which avoids proximity to heat generating components.

The voltage characteristic, by contrast, only has a negative gradient, with a limit expressed by the VCR, which is typically -1 to $5\text{ppm}/\text{V}$. High voltage resistors use special design techniques to minimize VCR, but ultimately there is a trade-off between VCR and product size. It should be noted that, as the gradient increases at high voltage, VCR error can be reduced by only operating the resistor at up to 75% of the full rated voltage. Resistors are normally adjusted and measured at voltages V_{measure} 100V, but TT Electronics can also supply resistors with an adjustment offset which minimizes the VCR error at a given higher nominal operating voltage.

Typical Temperature and Voltage Characteristics for Thick-Film Resistors

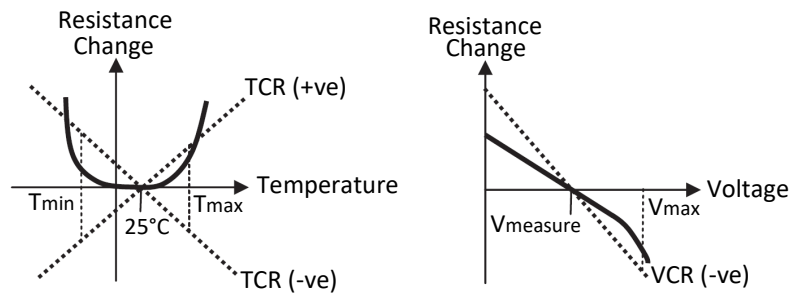

Figure 2

General Note
TT Electronics reserves the right to make changes in product specification without notice or liability. All information is subject to TT Electronics' own data and is considered accurate at time of going to print.

Contact: Defibrillator Charge Control (Cont.)

The environmental stability describes the limits of non-reversible resistance change under given loading and environmental conditions. The most demanding condition is high humidity, but TT Electronics optionally seals the resistive element using a specially formulated powder coat material to achieve typical resistance changes within $\pm 0.1\%$ on both Moisture Resistance and Biased Humidity tests.

High Voltage Planar SIL Resistors

HVP Series



- Compact design with minimal footprint
- Sealed by high-density epoxy protection
- Low TCR and VCR
- Leadframe standoff permits thorough washing
- Custom sizes, ratings and HV screening
- Integrated divider version available as HVD Series
- Optional powder coated version

High Voltage Chip Resistors

HVC Series

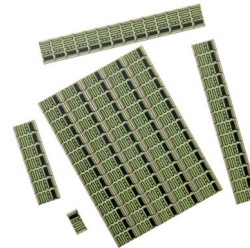

- Standard SMD chip format
- Continuous rating to 3kV
- Low voltage coefficient
- Tolerance to $\pm 0.5\%$
- TCR to $\pm 50\text{ppm}/^\circ\text{C}$

Electrical Data HVC Series & HVP Series		HVC1206	HVC2010	HVC2512	HVP	Notes
Power rating @70°C	watts	0.3	0.5	1	0.4 - 2	
Limiting element voltage	volts	1000	2000	3000	2000-20,000	DC or AC peak
Overload voltage (2s)	volts	1500	3000	4000		
Resistance range	ohms	10K to 1G			1K to 10G	Consult factory for out of range values
Resistance tolerance	%	0.5, 1, 2, 5, 10			0.25,0.5,1,5	See datasheet for applicable value ranges
TCR	ppm/°C	50, 100			25,50,100	
Ambient temperature range	°C	-55 to + 155				
Values		E24 & E96 preferred				Any value to order
VCR	ppm/V	-15	-5	-1.5	-0.5 to -1	Typical
Further data		Datasheet			Datasheet	

General Note

TT Electronics reserves the right to make changes in product specification without notice or liability. All information is subject to TT Electronics' own data and is considered accurate at time of going to print.

Contact: Defibrillator Pulse Protection

The possibility of exposure to defibrillation pulses exists for any directly connected monitors, and it is necessary to guard against damaging the sensitive input stages of such equipment. It is even more important to avoid diverting the defibrillation energy from the patient. This is achieved by adding resistance to the monitor input circuit, usually in the form of a pulse withstanding resistor. This is built into the leadset, either at the probe connector or in the yoke where the single cable breaks out into individual probe leads. Additional protection may be provided within the monitor itself. The standard test circuits are shown in Figure 3.

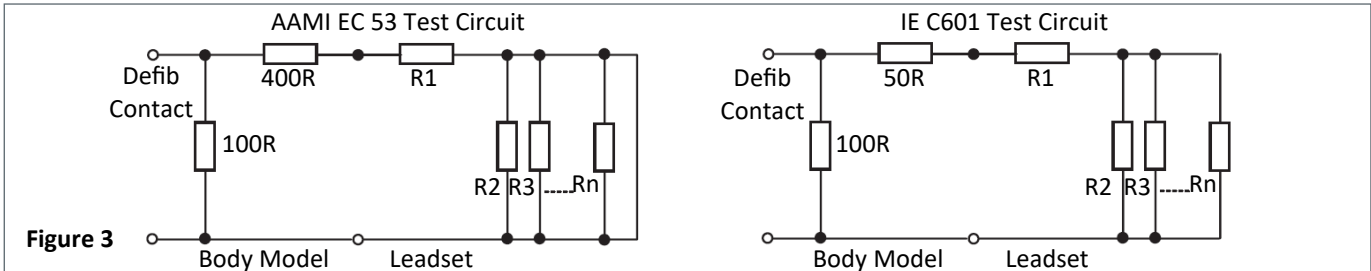

The proportion of the total defibrillation energy received by a protection resistor depends on its ohmic value, and the highest value consistent with monitor function should be used to minimize this. There is also a variation depending on which test circuit is used, and, in the case of IEC601, on how many leads are in the leadset.

TT Electronics can advise on the exact energy rating required, but 25J at 1K falling to 2.5J at 10K are typical values for leadset protection, and this calls for a composition technology product such as CC series. For PCB mounted resistors offering secondary protection, pulse withstanding thick-film products such as PWC, DSC and DPCR series are used.

High Energy Composition Resistors

CC Series



- Carbon composite element
- Energy rating to 30J
- High voltage epoxy coating

Pulse Withstanding Chip Resistors

PWC, DSC & DPCR Series

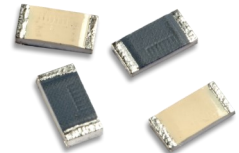

- Standard SMD chip with guaranteed pulse performance
- Defibrillation pulse chip resistor DPCR
- DSC is double sided for double energy capacity

Electrical Data CC, PWC, DSC & DPCR Series		CC Series	PWC2512	DSC2512	DPCR2512
Power rating	watts	1 & 2	1.5	1.5	1.5
Energy rating (10ms pulse)	volts	20 to 30	1	2	4
Resistance range	ohms	100R - 50K	1R - 10M	1R - 4M7	20K - 100K
Resistance tolerance	%	10, 20	0.5, 1, 5		5
Further data		Datasheet	Datasheet	Datasheet	Datasheet

General Note
TT Electronics reserves the right to make changes in product specification without notice or liability. All information is subject to TT Electronics' own data and is considered accurate at time of going to print.

Contact: ECG High Gain Amplification

Where ECG monitors and analytical instruments require sensitive first stages for amplification of small signals, high ohmic values are required in the feedback resistor (Figure 4). TT electronics has long specialized in providing values outside the range normally available, with some specialist products extending to 100TΩ (10¹⁴Ω). These are glass sealed resistors with the option of a guard-band for mitigation of leakage effects. In the flat chip format values extend to 50G and special sizes are available to minimize shunt capacitance and capacitance to ground plane.

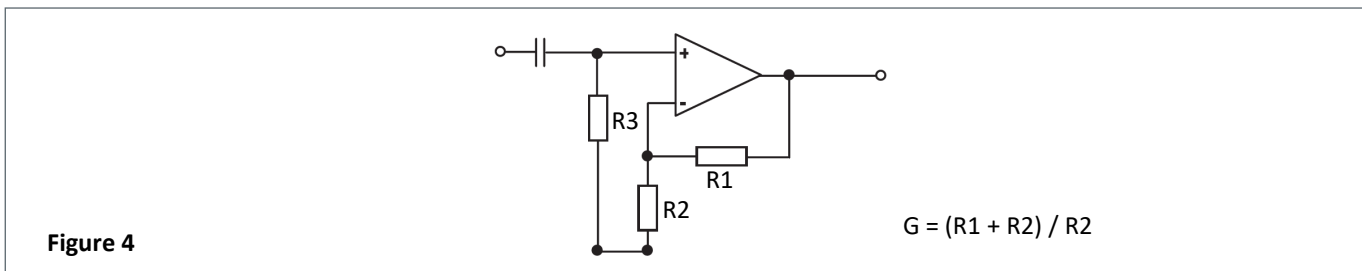

Ultra-High Value Resistors

3810 Series



- Values up to 100T
- Precision to 1% at 1T
- Silicone coated glass body

High Value Chip Resistors

HR Series

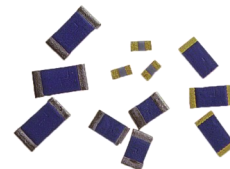

- Standard SMD chip up to 50G
- Precision to 5% at 1G
- Solder or wire bond terminations

Electrical Data 3810 Series & HR Series		3810	3811	3812	HR0805	HR1206
Resistance range	watts	100M - 1T		1T - 100T	100M to 50G	
Limiting element voltage	volts	500	1000		100	200
Further data		Datasheet			Datasheet	

Medical Resistors

Image: X-Ray Supply

X-ray systems require stable and accurate high voltage supplies to provide the accelerating voltage for X-ray generation. Voltages are typically in the 50kV to 100kV range, and the circuit is often assembled in an oil-filled chamber. This reduces clearance and creepage constraints on the components and layout, thus enabling a compact X-ray head design.

TT Electronics has extensive experience of supplying ultra-high voltage thick-film solutions for voltage division in this application and can supply various standard and custom formats. One design approach is to use a series combination of high voltage resistors

such as HVP Series (see Page 4 for data) which provides up to 20kV per element. Another solution is to use T Series axial resistors which provide up to 100kV in a single element in an oil-filled or SF6-filled assembly. Terminations are either wire or screw, allowing easy stacking into multiple resistor assemblies. In order to eliminate the possibility of air pockets the unsleeved version (pictured) should be selected. It is possible to supply these parts in matched sets to give accurate ratio tolerance or to give very low TCR by means of cancellation. Finally, custom divider networks can be designed with track layouts and component outlines which give optimized solutions for highly compact head designs.

Ultra-High Voltage Resistors

T Series

- LEV to 100kV
- Values up to 50G
- Precision to 0.5% 25ppm
- Matched sets available



Custom Resistor & Divider Networks

- Good ratio tolerance and TCR tracking
- Optimized size and shape
- Ideal for compact head designs



Electrical Data T Series		T43	T44	T48	Notes
Limiting element voltage	volts	4000 / 8000	14,000 / 28,000	50,000 / 100,000	In air / in oil
Power rating @20°C	watts	1.5 / 2.3	3.5 / 5.3	10 / 15	
Resistance range	ohms	1K to 50G			
Tolerance	%	1, 2, 5			0.5% in restricted range
TCR	ppm/°C	25, 50, 100			
Further data		Datasheet			

General Note

TT Electronics reserves the right to make changes in product specification without notice or liability. All information is subject to TT Electronics' own data and is considered accurate at time of going to print.

Medical Resistors

Image: Medical Scanners

Ultrasound transducers require termination networks capable of operating at high frequency and providing multiple channels of resistive termination. A typical requirement is 128 channels and performance up to 15MHz. TT Electronics can provide standard and custom thin-film resistor networks in a wide variety of packaging styles including SOIC, QSOP, TSSOP. The latest addition is a BGA part which can offer up to 32 terminators in a 6.4 x 2.5mm footprint with return loss below -20dB to 3GHz. This meets the requirement above within the space of four 2512 chips.

MRI scanners require control circuits which are insensitive to extremely high magnetic field strengths, and this calls for components which are free of ferrous alloys and nickel. These are the materials commonly used in the termination caps fitted to the ends of most types of axial resistor and as an anti-leaching barrier in chip resistors. TT Electronics can supply the non-magnetic glueable chip, GCR Series, for this requirement.

BGA Network

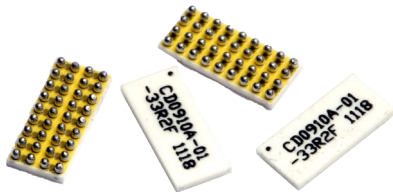

Non-Magnetic Chip Resistors



Analysis: Precision Resistors

For a broad range of laboratory analysis equipment, Precision resistors are required with tight tolerance, low temperature sensitivity and high stability. The input stage of an instrument with a resistive sensor, for example a thermistor in a precision temperature monitoring circuit, consists of a bridge of resistors which must be closely matched in value (Figure 5). In such a case it is the ratio between values which matters rather than the absolute values themselves. Likewise, the maximum difference between TCRs, that is the tracking TCR, is more important than the absolute TCR. TT Electronics can offer two solutions in these cases. Firstly, most through-hole precision resistors are available in matched sets with specified ratio tolerance and tracking TCR, and this solution gives







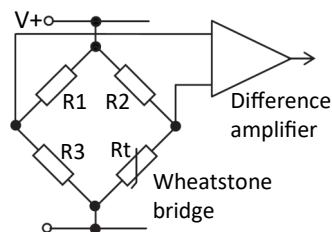

the best available precision. Secondly, SMD thin-film products with multiple elements provide a combination of high precision and a compact single-component solution.

The precision through-hole resistor offering ranges from semiprecision PR Series through the popular precision RC Series to ultraprecision MAR which matches the performance of costly metal foil technology using advanced metal film techniques. The precision SMD offering includes conventional thin-film chip resistors using nichrome elements as well as ultra high stability versions which exploit the self-passivating properties of tantalum nitride film (WIN Series).

Figure 5



Analysis: Precision Resistors (Cont.)

Format	Product	Absolute Tolerance %	Ratio Tolerance %	Absolute TCR ppm/°C	Tracking TCR ppm/°C	Further Data
Through-hole	PR	0.1		25		 Datasheet
	RC 0.25 to 1W	0.05	0.02	5	2	 Datasheet
	RCP 0.5 to 1.5W	0.05	0.02	5	2	 Datasheet
	CAR 0.25 to 0.5W	0.01	0.005	5	1	 Datasheet
	MAR 0.3W	0.005	0.005	2	1	 Datasheet
SMD	PCF 0.063 to 0.25W	0.1		10		 Datasheet
	WIN 0.1 to 0.33W	0.05		15		 Datasheet
	PFC-DIVIDER 0.25W total		0.02		5	 Datasheet

* For through-hole parts, applies to matched sets

For our full product portfolio, in-house & local design support / distribution partners, visit:
<https://www.ttelectronics.com/products/categories/passive-components/>