



ABSP

Intervehicle Connectors

**TT** electronics

*AB Connectors Limited*

# Single Pole Connections

## CONVERSION TABLE - ASSEMBLIES

THE TABLES BELOW OUTLINE AB CONNECTORS NUMBERS TO FIGHTING VEHICLE NUMBERS

The original Fighting Vehicle part numbers called for a standard version (up to 100°C) and a high temperature version (up to 150°C). AB Connectors have standardised on the high temperature version for all applications, limiting the number of part numbers required by customers.

FIXED CONNECTORS		Fixed Plug		
		AB CONNECTOR No.	LOW TEMP FV No.	HIGH TEMP FV No.
		ABSP-P-P-T	FV131143	FV892670

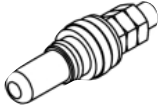

FIXED CONNECTORS		Fixed Socket		
		AB CONNECTOR No.	LOW TEMP FV No.	HIGH TEMP FV No.
		ABSP-P-S-T		FV892658

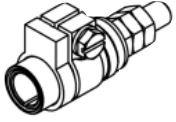

FREE CONNECTORS		Straight Plug		
Wire Size AWG	Approx Conductor DiaNo.	AB CONNECTOR No.	LOW TEMP FV No.	HIGH TEMP FV No.
8	4.2	ABSP-C-P-95	FV892654	FV892694
2	8.5	ABSP-C-P-95	FV892655	FV892695
00	12.4	ABSP-C-P-135	FV892656	FV892696
0000	16.1	ABSP-C-P-165	FV892657	FV892697

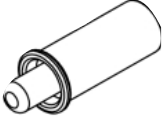

FREE CONNECTORS		Straight Socket		
Wire Size AWG	Approx Conductor DiaNo.	AB CONNECTOR No.	LOW TEMP FV No.	HIGH TEMP FV No.
8	4.2	ABSP-C-S-95		
2	8.5	ABSP-C-S-95	FV131170	FV892673
00	12.4	ABSP-C-S-135	FV131144	FV892671
0000	16.1	ABSP-C-S-165	FV131169	FV892672

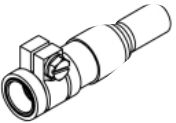

FREE CONNECTORS		90° Plug		
Wire Size AWG	Approx Conductor DiaNo.	AB CONNECTOR No.	LOW TEMP FV No.	HIGH TEMP FV No.
8	4.2	ABSP-C90-P-95		
2	8.5	ABSP-C90-P-95	FV292428	FV892683
00	12.4	ABSP-C90-P-135	FV292425	FV892682
0000	16.1	ABSP-C90-P-165	FV292422	FV892681







FREE CONNECTORS		90° Socket		
Wire Size AWG	Approx Conductor DiaNo.	AB CONNECTOR No.	LOW TEMP FV No.	HIGH TEMP FV No.
8	4.2	ABSP-C90-S-95		
2	8.5	ABSP-C90-S-95	FV604009	FV892690
2	8.5	ABSP-C90-S-95	FV604010	FV892691
00	12.4	ABSP-C90-S-135	FV604014	FV892693
0000	16.1	ABSP-C90-S-165	FV604011	FV892692





# Single Pole Connections

CONVERSION TABLE - COMPONENTS

THE TABLES BELOW OUTLINE AB CONNECTORS NUMBERS TO FIGHTING VEHICLE NUMBERS.

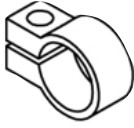
SPARE PARTS		Insulators		
	AB CONNECTOR	LOW TEMP FV No.	HIGH TEMP FV No.	
Fixed Pin Insulator	ABSP-0002	FV131069	FV892668	
	AB CONNECTOR	LOW TEMP FV No.	HIGH TEMP FV No.	
Fixed Washer	ABSP-0004	FV39352	FV892660	
	AB CONNECTOR	LOW TEMP FV No.	HIGH TEMP FV No.	
Fixed Socket Insulator	ABSP-0006	FV 534898		
	AB CONNECTOR	LOW TEMP FV No.	HIGH TEMP FV No.	
Free Socket Insulator	ABSP-0012	FV131070		
	AB CONNECTOR	LOW TEMP FV No.	HIGH TEMP FV No.	
90° Socket Insulator	ABSP-0020	FV534898	FV892687	

SPARE PARTS		Clamps		
	AB CONNECTOR	LOW TEMP FV No.	HIGH TEMP FV No.	
Short Clamp	ABSP-0007	FV39353	N/A	
	AB CONNECTOR	LOW TEMP FV No.	HIGH TEMP FV No.	
Medium Clamp	ABSP-0024	FV534897	N/A	
	AB CONNECTOR	LOW TEMP FV No.	HIGH TEMP FV No.	
Long Clamp	ABSP-0008	FV131071	N/A	

Panel Cut-out Information

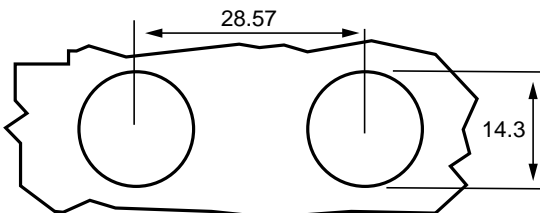

## Single Pole Connections

### Fixed Connector Assemblies

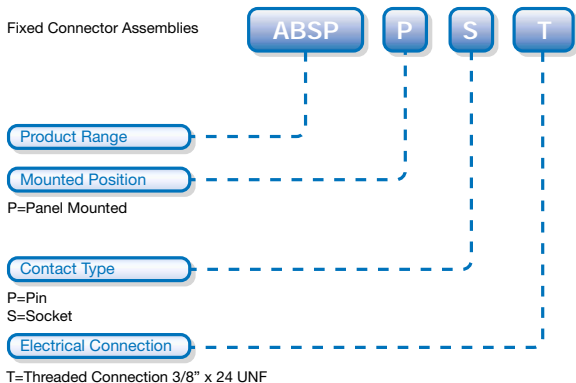

### Free Connector Assemblies

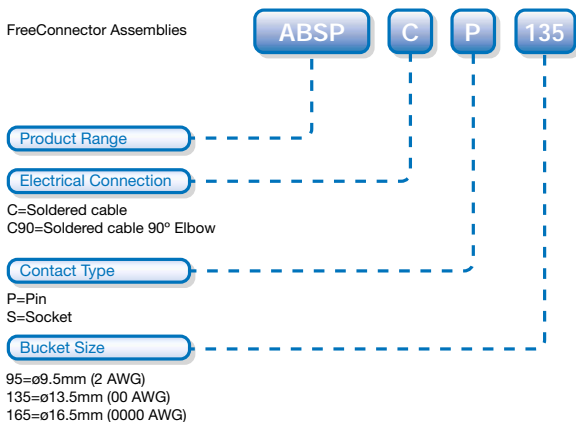

Mono pin connection capable of carrying high current at high temperatures. Connection is retained by a binding clamp allowing quick fit and release for ease of assembly. The ABSP range employs a superior insulator material that gives excellent impact resistance, even at low temperatures. All the materials used in the ABSP range are low smoke, low toxicity.

### Specifications

Temperature Rating	+150°C to -40°C Continuous Operating
Current Rating	300A Continuous 1200A for 1 Minute Based on 0000 cable
Operating Voltage	50V
Voltage Proof	3kV
Clamp Screw Torque	5.6Nm (50lb/in)
Panel Mounted	3/8" x 24 UNF
Terminal Thread	

### Standard Cable Sizes used with ABSP Range.

Wire Size AWG	Approximate Conductor Dia
8	4.2
2	8.5
00	12.4
0000	16.1

**TT electronics**  
**AB Connectors Limited**

AB Connectors Limited  
Abercynon,  
Mountain Ash  
Rhondda Cynon Taff  
CF45 4SF, UK.  
Tel: +44(0)1443 740331  
Fax: +44(0)1443 741676  
Internet:  
<http://www.ttabconnectors.com>  
Email:  
[sales@ttabconnectors.com](mailto:sales@ttabconnectors.com)

AB Connectors Limited  
PO Box 2240,  
2500 Business Highway 70  
East  
Smithfield,  
NC 27577, USA  
Tel: + (1)919 934 5181  
Fax: + (1)919 934 0652  
Email:  
[abconnectors@abautomotive.com](mailto:abconnectors@abautomotive.com)  
[usa.com](http://usa.com)