

17 mm Rotary Potentiometer with Push-Pull Switch

P161 Series



OBSOLETE



Features:

- Resistance range 1 k Ω to 1 M Ω
- Temperature range -10°C to +70°C
- Rotational cycles of 15,000 minimum
- Switch option
- Vertical and horizontal mount versions
- RoHS compliant

Description:

17mm rotary dual gang potentiometer with push-pull switch. Options include metal shaft; audio and linear tapers; metal bushing; knurled or plain shaft types.

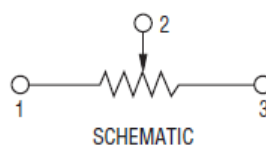

Single Gang

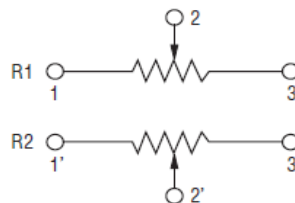

Dual Gang

Applications:

- Electric guitars
- Amplifiers
- Mixers
- Drum machines
- Synthesizers

Electrical Characteristics

T_A = 25°C unless otherwise noted

Resistance Range	1 k Ω to 1 M Ω
Standard Resistance Tolerance	500 Ω < R < 1 M Ω \pm 20% R \leq 500 Ω or R \geq 1 M Ω \pm 30%
Residual Resistance	Term. 1~2: Less than 20 Ω Term: 2~3: Less than 20 Ω
Resistance Taper	A, B, C, D
Maximum Operating Voltage	Linear Taper B: 200 Vac Other Tapers: 150 Vac
Rated Power	Linear Taper B: 0.2 W Audio: 0.1 W
Dielectric Strength	1 minute at 500 Vac
Rotational Noise	Less than 100 mV
Insulation Resistance	More than 100 M Ω at 500 Vdc
Gang Error (Dual Unit)	-40 dB ~ 0 dB \pm 3 dB

General Note

TT Electronics reserves the right to make changes in product specification without notice or liability. All information is subject to TT Electronics' own data and is considered accurate at time of going to print.

17 mm Rotary Potentiometer

P161 Series



OBSOLETE

Switch Characteristics

T_A = 25°C unless otherwise noted

Switch Circuit	SPST
Contact Resistance	Less than 50 mΩ
Rated Power	Single Unit: 1.0 A at 12 Vac/dc
Push/Pull Travel	4 mm
Push/Pull Strength	70~250 gf.cm.
Switch Life	15,000 cycles minimum

Mechanical Characteristics

T_A = 25°C unless otherwise noted

Mechanical Travel	300 ° ± 5 °
Rotational Torque	20 gf.cm~200 gf.cm
Rotational Stop Strength	6 kgf.cm minimum
Shaft Pull Strength	6 kgf minimum for 60 seconds
Detent Torque	100~300 gf.cm
Nut Tightening Strength	8 kgf.cm minimum
Rotational Life	15,000 cycles minimum

Environmental Characteristics

T_A = 25°C unless otherwise noted

Operating Temperature	-10 °C to +70 °C
IP Rating	IP 40
Soldering Condition	Wave Soldering 260 °C maximum for 1-3 seconds Hand Soldering 300 °C maximum for 3 seconds
RoHS	Please refer to TT Electronics website
REACH	Please refer to TT Electronics website

17 mm Rotary Potentiometer

P161 Series



OBSOLETE

Ordering Information

P161	G	1	00	Q	S	C	20	B	102
------	---	---	----	---	---	---	----	---	-----

Part Family

Terminal Configuration

G - PC Pins, Down Facing
 K - Solder Lugs, Rear Facing

Gang Number

1 - 1 Gang
 2 - 2 Gangs (Only w/ Term. Type "G")

Detents/ Rotation

00 - No Position
 01 - Center Detent

Shaft Style

Q - Metal Knurled Type
 P - Metal Plain Type Shaft

Switch Option

S - Push-Pull Switch

Full CCW Position

A/C/N (see note 1 page 4)

Shaft Length (mm) - L

20/25/30

Resistance Taper

A - Audio (15A)
 B - Linear (1B)
 C - Reverse Audio (15C)
 D - Audio (10A)

Resistance

See Resistance Table

Resistance (Ohms)	Code
1,000	102
2,000	202
5,000	502
10,000	103
20,000	203
50,000	503
100,000	104
200,000	204
500,000	504
1,000,000	105

General Note

TT Electronics reserves the right to make changes in product specification without notice or liability. All information is subject to TT Electronics' own data and is considered accurate at time of going to print.

OBSOLETE

Outline Drawings

Shaft Style & Length

Q Type—With Switch Option			
L	20	25	30
	P - 12	P - 14	P - 14
	T - 10	T - 12	T - 12
	M - 2	M - 2	M - 4

P Type			
L	20	25	30

Q-Type Shaft

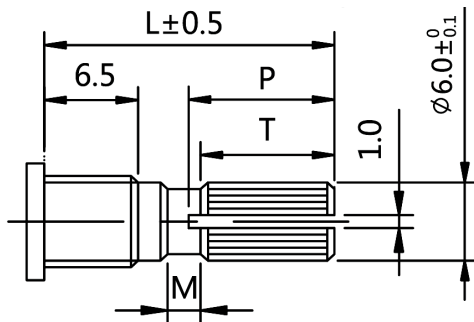

P-Type Shaft

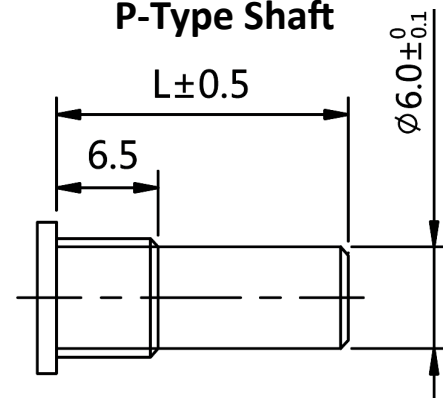

Note 1: Full CCW Position

Q-Type Shaft

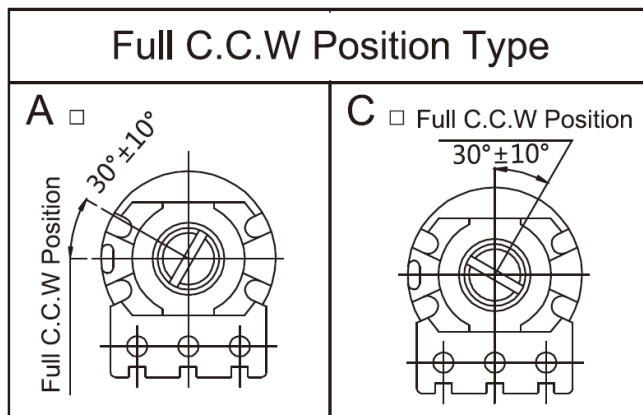

P-Type Shaft

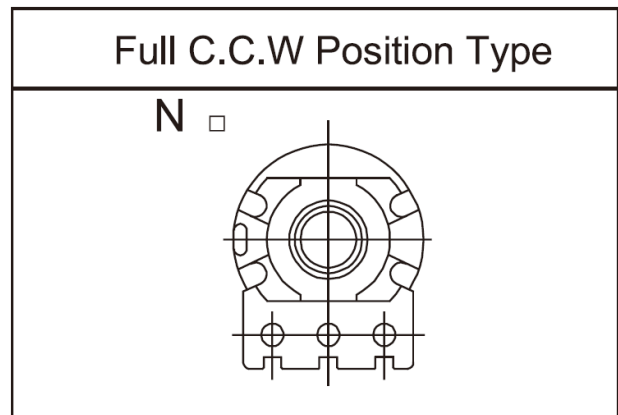

17 mm Rotary Potentiometer

P161 Series



OBSOLETE

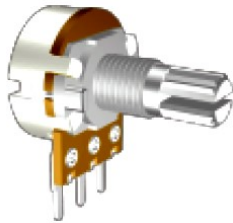

G - PC Pins, Down Facing, Single Gang with Push-Pull Switch

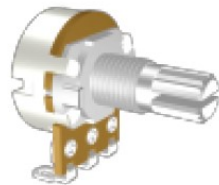
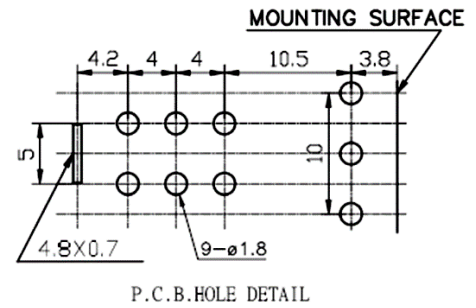
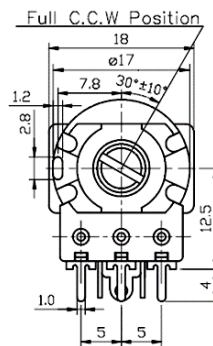
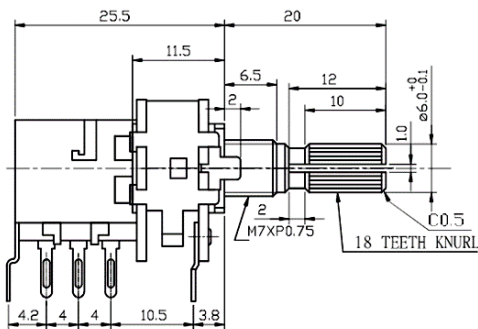

K - Solder Lugs, Rear Facing, Single Gang with Push-Pull Switch

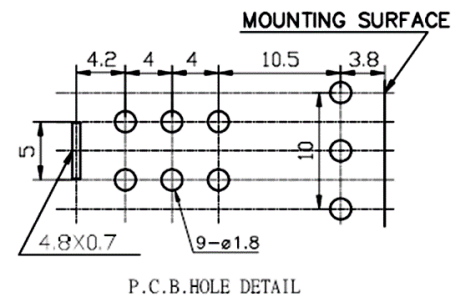
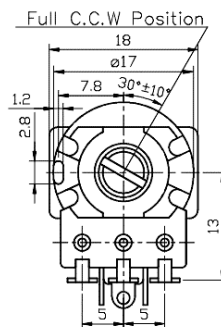
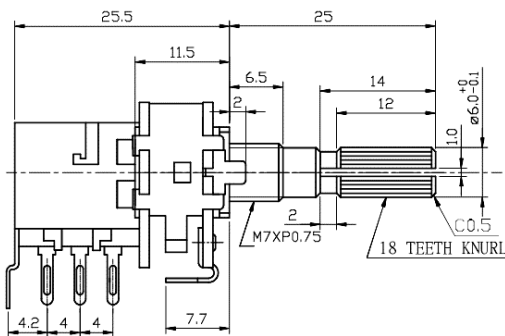

General Note

TT Electronics reserves the right to make changes in product specification without notice or liability. All information is subject to TT Electronics' own data and is considered accurate at time of going to print.

© TT electronics plc

TT Electronics | BI Technologies
 Circulo de la Amistad #102 PIMSA IV Mexicali B.C. Mexico C.P 21210
 Ph: + 1 (714) 447-2345
www.ttelectronics.com/bi-technologies

Rev - 06/2019 Page 5

Document No.: _____

17 mm Rotary Potentiometer

P161 Series



OBSOLETE

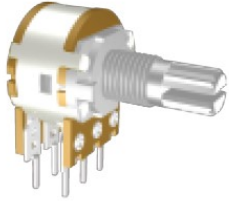

G - PC Pins, Down Facing, Dual Gang with Push-Pull Switch

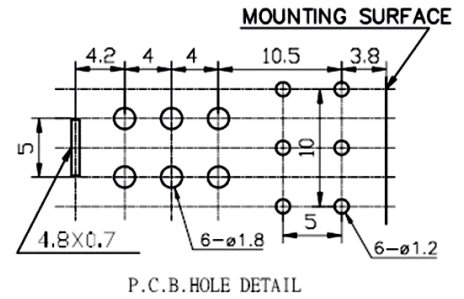
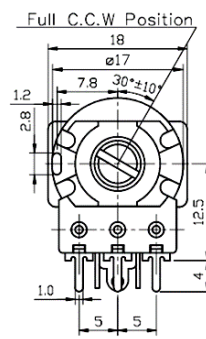
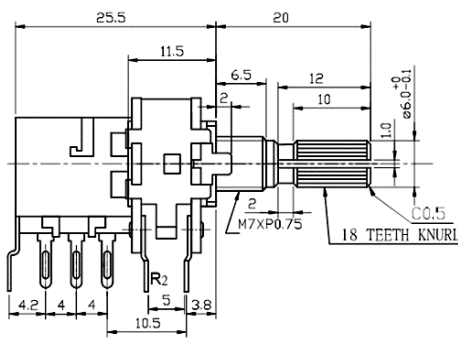

General Note
TT Electronics reserves the right to make changes in product specification without notice or liability. All information is subject to TT Electronics' own data and is considered accurate at time of going to print.

© TT electronics plc

TT Electronics | BI Technologies
Circulo de la Amistad #102 PIMSA IV Mexicali B.C. Mexico C.P 21210
Ph: + 1 (714) 447-2345
www.ttelectronics.com/bi-technologies

Rev - 06/2019 Page 6

Document No.: _____

17 mm Rotary Potentiometer

P161 Series



OBSOLETE

Standard Tapers

"A" AUDIO (15A)
Middle without tap

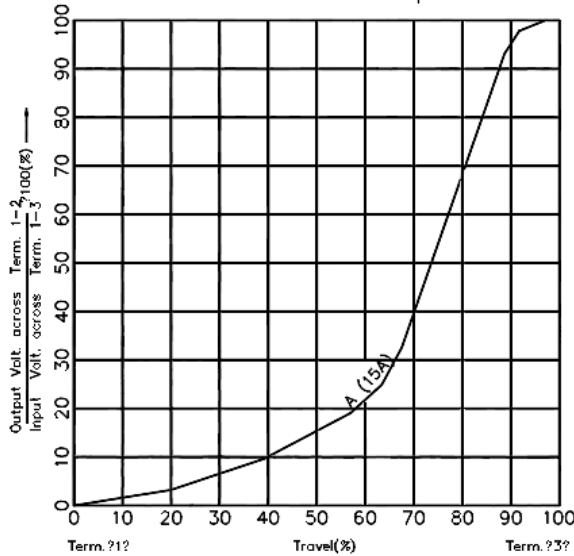

"B" LINEAR (1B)
Middle without tap

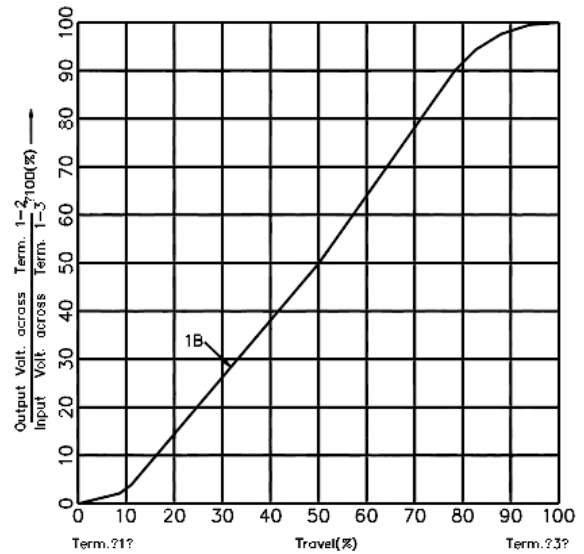

"C" REVERSE AUDIO (15C)
Middle without tap

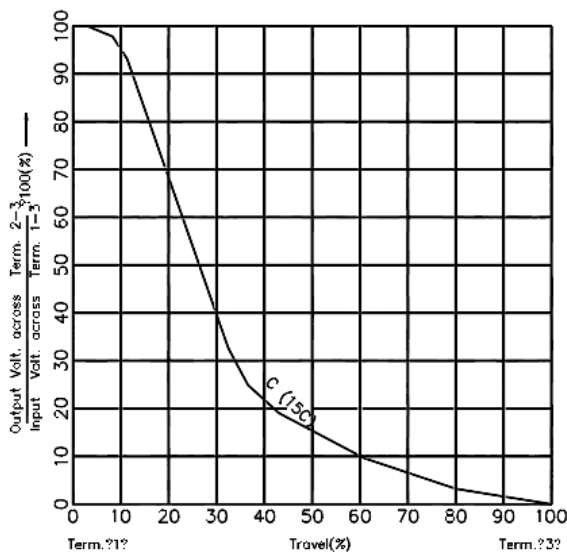

"D" AUDIO (10A)
Middle without tap

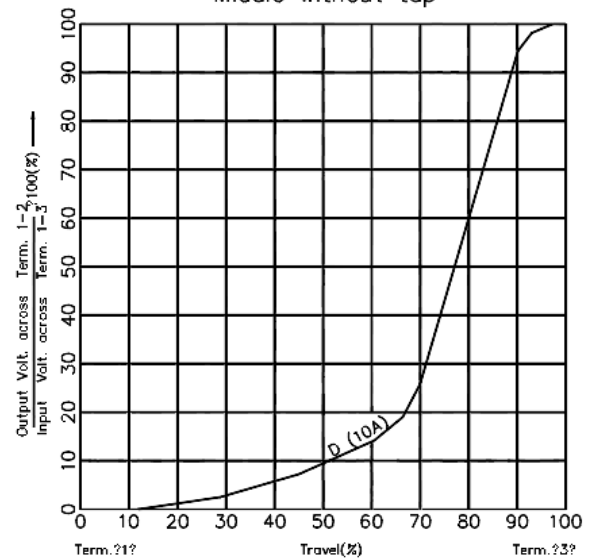

General Note

TT Electronics reserves the right to make changes in product specification without notice or liability. All information is subject to TT Electronics' own data and is considered accurate at time of going to print.

© TT electronics plc

TT Electronics | BI Technologies
Circulo de la Amistad #102 PIMSA IV Mexicali B.C. Mexico C.P 21210
Ph: + 1 (714) 447-2345
www.ttelectronics.com/bi-technologies

Rev - 06/2019 Page 7

Document No.: _____

17 mm Rotary Potentiometer

P161 Series

OBSOLETE

Screw & Washer Dimensions

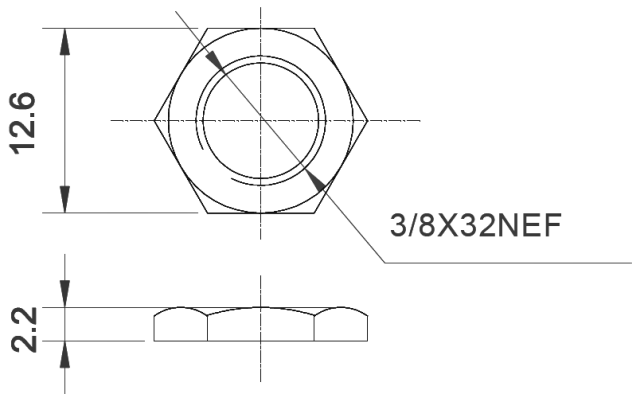

NUT 1 PC

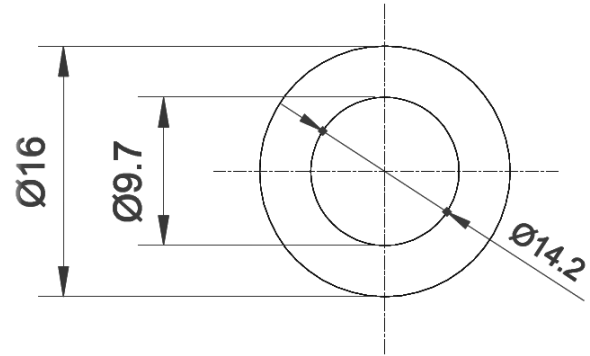

WASHER 1 PC t=0.4

Packaging Information

Standard Packaging	Plastic Trays
Hardware	Two flat washers and mounting nut