

Power Inductors

HA72L-1770 series



Features:

- Operating Temperature Range -55°C to $+155^{\circ}\text{C}$
- Ambient Temperature, Maximum $+115^{\circ}\text{C}$
- Temperature Rise, 40°C
- RoHS Compliant
- AEC-Q200 Certified

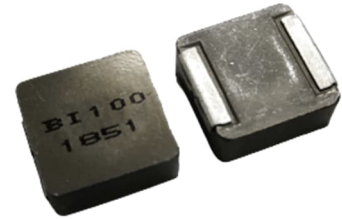

Description:

HA72L series molded inductors are designed with the latest composite molded core materials made from iron alloy core to maximize inductance, temperature performance and saturation current while minimizing DC resistance and physical size. The result is a compact, surface mount component that operates in demanding environment with saturation currents up to 80 amps. It is magnetically shielded.

The HA72L series has been designed as a 155°C high temperature rated molded inductor for high stress environment that require high current saturation levels. It is ideal for high power density applications where size is critical and AEC-Q200 performance is certified.

Due to their iron alloy core properties, HA72L series offers good temperature flux density. They are also ideal for high efficiency DC-DC converters using high switching frequencies up to 3 MHz as well as EMI and low pass DC ripple filters in high temperature environment. Molded inductors deliver clean power in a small, lightweight surface mount package. AEC-Q200 certification assures performance and reliability levels that automotive applications demand.

Applications:

- Transportation
 - * Lighting
 - * Engine Control
 - * Transmission control
 - * Powertrain
 - * Braking
 - * Electric power steering

General Note

TT Electronics reserves the right to make changes in product specification without notice or liability. All information is subject to TT Electronics' own data and is considered accurate at time of going to print.

Electrical Specifications

Part Number	⁽¹⁾ Inductance (μ H) $\pm 20\%$ @0A	DCR (m Ω) Typ	DCR (m Ω) Max	SRF (MHz) Ref	⁽²⁾ Irms (A)	⁽³⁾ Isat (A)
HA72L-1770R82LFTR	0.82	0.98	1.08	35	50.0	45.0
HA72L-17701R0LFTR	1.00	1.21	1.27	28	49.0	32.0
HA72L-17701R5LFTR	1.50	1.54	1.62	23	40.0	31.0
HA72L-17702R2LFTR	2.20	1.85	1.98	17	35.0	28.0
HA72L-17703R3LFTR	3.30	2.79	2.93	-	29.0	27.0
HA72L-17704R7LFTR	4.70	3.98	4.18	12	25.0	21.0
HA72L-17705R6LFTR	5.60	4.23	4.44	-	25.0	21.0
HA72L-17706R8LFTR	6.80	5.86	6.15	-	21.0	18.5
HA72L-17708R2LFTR	8.20	7.71	8.10	-	18.0	18.0
HA72L-1770100LFTR	10.0	8.89	9.33	7	18.0	17.0
HA72L-1770150LFTR	15.0	13.7	14.4	-	14.0	12.0
HA72L-1770220LFTR	22.0	20.0	21.0	-	11.0	9.5
HA72L-1770330LFTR	33.0	35.1	37.0	-	10.0	9.0
HA72L-1770470LFTR	47.0	40.7	42.7	2	8.0	8.6
HA72L-1770560LFTR	56.0	55.0	57.8	-	6.5	8.0
HA72L-1770680LFTR	68.0	72.1	75.7	3	6.0	6.0
HA72L-1770820LFTR	82.0	87.3	91.7	3	4.8	5.4
HA72L-1770101LFTR	100.0	105.0	110.0	2	4.8	4.5

Notes: (1) Test condition is 100kHz @ 1V

(2) Irms is the approximate current at which $\Delta T = 40^{\circ}\text{C}$

(3) Isat is the saturation current at which inductance rolls off approximately 30% from its initial (zero DC) value.

General Note

TT Electronics reserves the right to make changes in product specification without notice or liability. All information is subject to TT Electronics' own data and is considered accurate at time of going to print.

© TT electronics plc

Performance

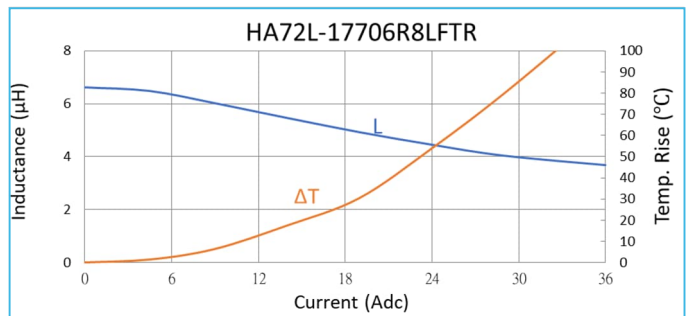
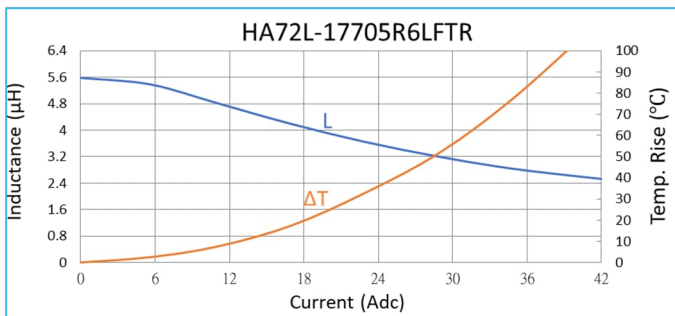
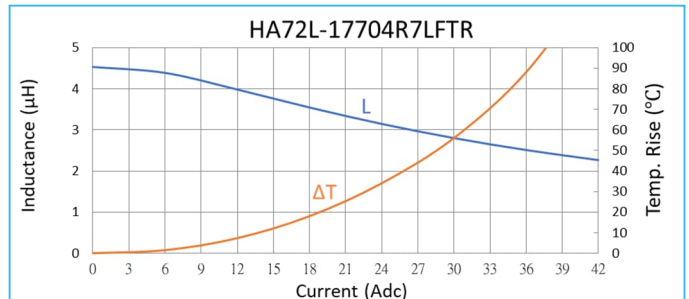
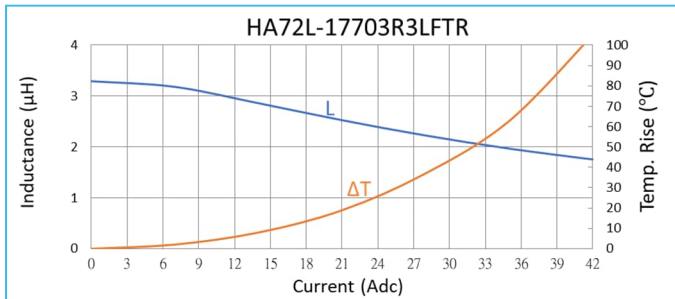
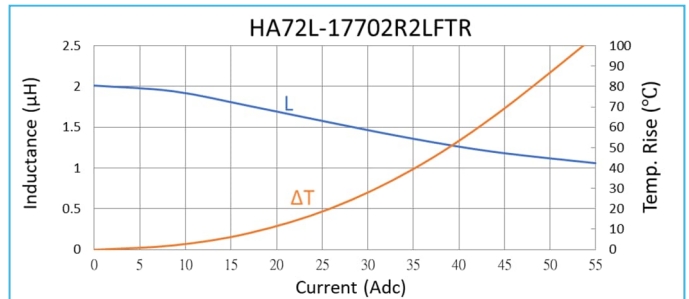
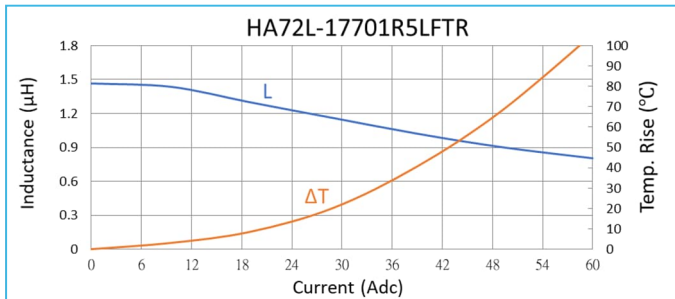
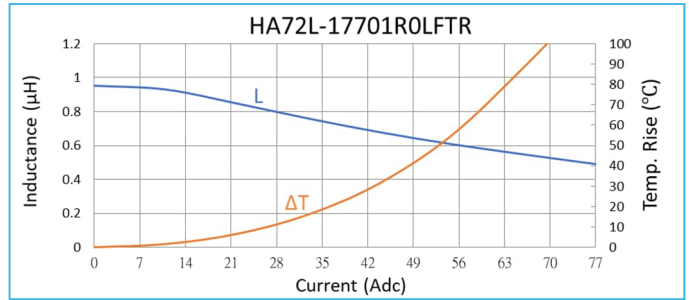
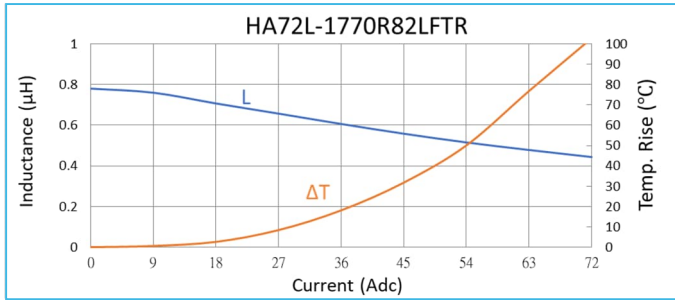

General Note
TT Electronics reserves the right to make changes in product specification without notice or liability. All information is subject to TT Electronics' own data and is considered accurate at time of going to print.

© TT electronics plc

TT Electronics | BI Technologies
A-1445, Jalan Tanjung Api, 25050 Kuantan, Pahang Darul Makmur, Malaysia
Ph: +60 9 565 8888
<https://www.ttelectronics.com/contact-us/>

Performance

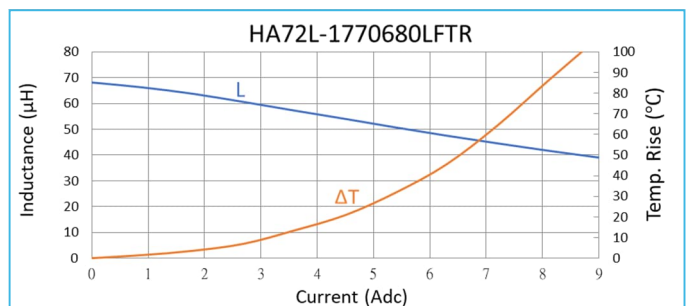
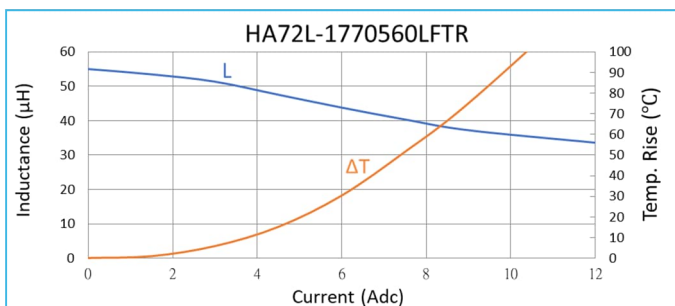
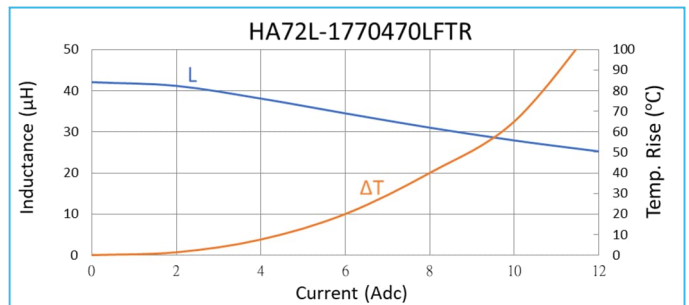
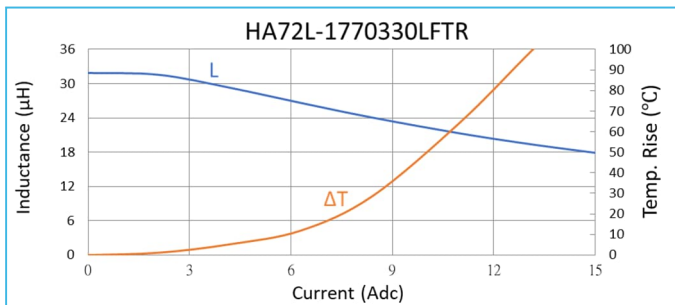
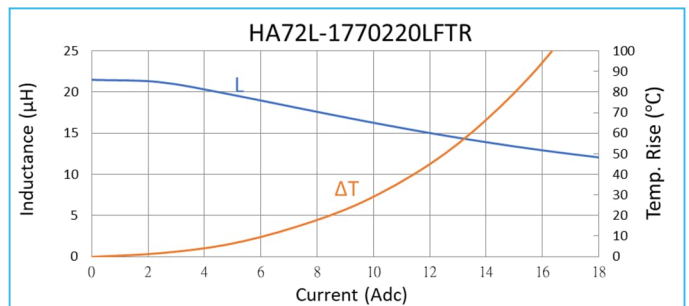
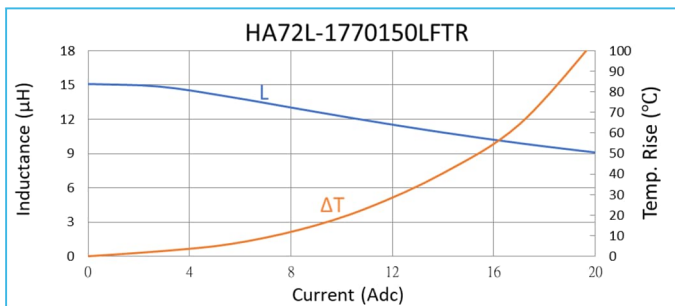
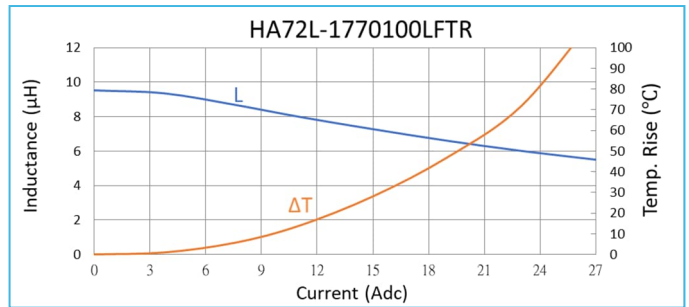
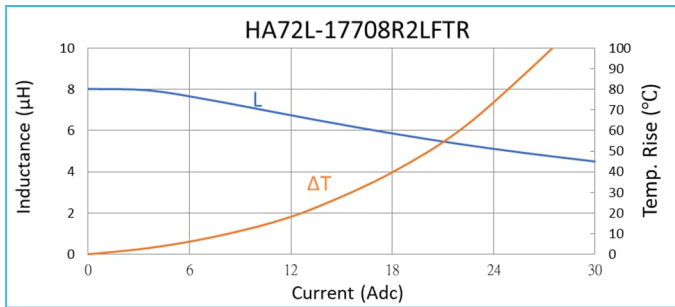

General Note
TT Electronics reserves the right to make changes in product specification without notice or liability. All information is subject to TT Electronics' own data and is considered accurate at time of going to print.

Performance

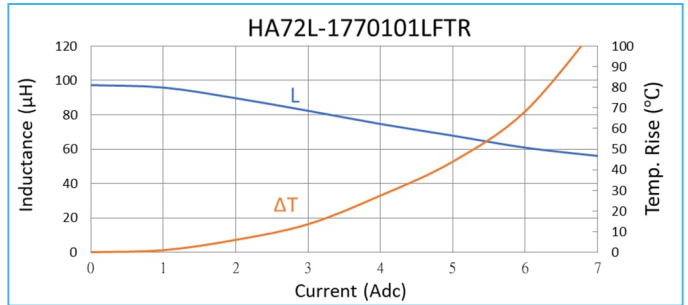
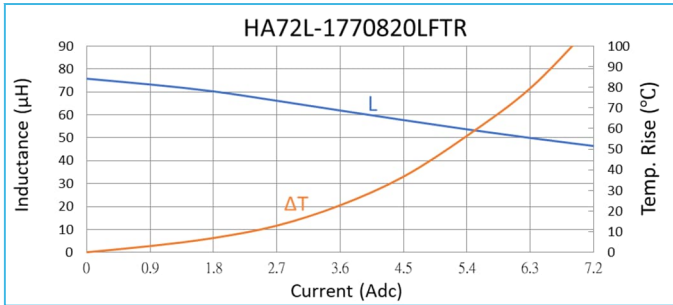

Outline Dimension (mm)

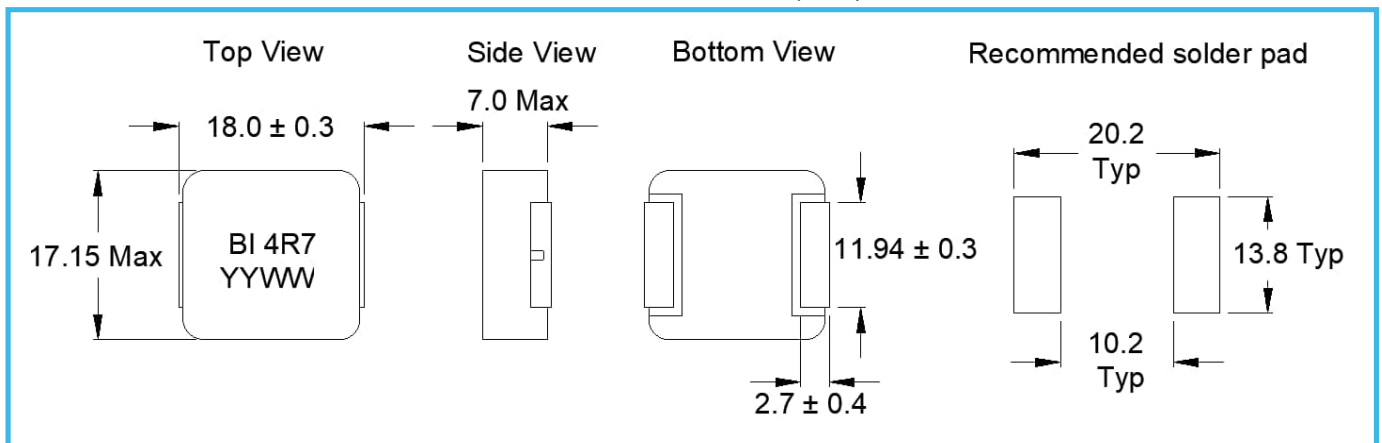

Ordering Information

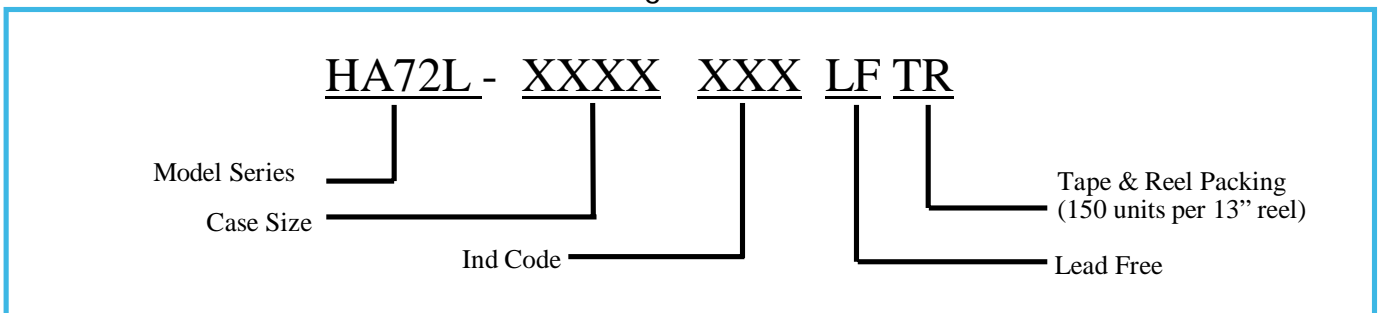

General Note
TT Electronics reserves the right to make changes in product specification without notice or liability. All information is subject to TT Electronics' own data and is considered accurate at time of going to print.

1. All components are manufactured, designed, and promoted for application in general electronic devices. For specific application uses such as in the automotive, medical, military, and aerospace industries other than general electronic devices, BI Technologies must be asked for written approval before incorporating the components into those areas. This clause can be omitted for any existing product or new product that had been designed and proven tested for critical application such as automotive, medical, military and aerospace industry.
2. Any components that will be used in high-reliability / high-level safety applications should be pre-evaluated by the end customer, especially in customer applications in which the malfunction or failure of an electronic component could endanger human life or health.
3. The customer shall be responsible for evaluating and confirming that BI Technologies' products are suitable for use in customer applications. If the customer applications require a very high level of operational safety, especially if failure of an electronic component could endanger human life or health, it must be ensured by using a suitable design of the customer application or other action taken by the customer such that no injury or damage is sustained by third parties in the event of a malfunction or failure of an electronic component.
4. Customers must be cautioned to verify that the data sheets are updated before placing orders, especially for standard series.
5. The customer needs to use the part within the warranty period as stated in the quotation. Any trouble or failure of electronic components happening during their long life span which cannot be eliminated even after following the instruction within existing technology, BI Technologies would not be liable for it.
6. Many coating/potting materials would shrink as they harden. They, therefore, apply pressure on the plastic housing or core. This pressure can affect electrical properties and, in extreme cases, can damage the core or plastic housing mechanically. It is necessary to check whether the coating or potting material used may attack or destroy the wire insulation, plastics, or glue. The effect of the coating or potting material can change the high-frequency behaviour of the components. Many coating and potting materials have a negative effect (chemically and mechanically) on the winding wires, insulation materials, and connecting points. Customers are always obligated to determine whether and to what extent their coating materials influence the component. Customers are responsible for and bear all risks associated with the use of the coating material. BI Technologies does not assume any liability for failures of our components that are caused by the coating material.
7. The washing/cleaning process may jeopardize the product and cause a defect. Washing agents may harm the long-term functionality of the product. The customer shall be responsible for evaluating and confirming the product is suitable for use in the customer's applications after the washing/cleaning process, as this is customer process-related.
8. Products should not be kept in unsuitable storage conditions, such as areas susceptible to high humidity, high temperatures, dust, or corrosion, where, for example, atmospheres should be free of chlorine and sulfur-bearing compounds. Recommended storage condition in general is +10°C ... +40 °C, humidity ≤75% RH. Temperature fluctuations should be minimized to avoid condensation on the parts. Avoid storage near strong magnetic fields, as this might magnetize the product.
9. The storage period should not be longer than 12 months (in the specific storage environment). Oxidization may occur on the terminals; therefore, all products shall be consumed within 12 months after the shipping date. If the time is longer than 12 months, please check the solderability before using it.
10. Don't touch electrode terminals directly with bare hands, as oil stains may inhibit proper soldering. Always ensure optimum conditions for soldering.
11. Terminals should not be bent or subjected to excessive stress. If the terminals are cable harness types, do not use the cable harness to carry the unit or pull the cable harness with force, it may cause failure on the unit immediately or have a latent effect.

General Note

TT Electronics reserves the right to make changes in product specification without notice or liability. All information is subject to TT Electronics' own data and is considered accurate at time of going to print.

© TT electronics plc

TT Electronics | BI Technologies
A-1445, Jalan Tanjung Api, 25050 Kuantan, Pahang Darul Makmur, Malaysia
Ph: +60 9 565 8888
<https://www.ttelectronics.com/contact-us/>

Issue C 12/2022 Page 6

12. Avoid placing magnetic components near the edge of the PCB. It is at the customer's discretion to have the proper design and PCB layout so that components are not damaged in any way during handling or cause any EMI issues.
13. Don't touch any exposed winding part and avoid coming into contact with the guide of the electrode as due to the charge stored may cause an electric shock. It is the customer's discretion to inform all relevant personal handling the components accordingly.
14. The inductor/coil/common mode choke generates heat when current is applied. Please take into consideration this during the design or testing stage.
15. Ferrites are sensitive to direct impact. This can cause the core material to flake, or lead to breakage of the core. Always handle the product with care to prevent any damage.
16. Our specification specifies the quality of the component as a single unit. Please ensure the component is thoroughly evaluated in the customer application circuit, therefor even for customized products, conclusive validation of the component in the circuit can only be carried out by the customer.
17. The general testing condition is at the room temperature of 25°C +/- 5°C and humidity under 70% RH, which is applied to all products. It is the customer's responsibility to validate that a particular product with the properties described in the product specification is suitable for use in a particular application. Parameters provided in datasheets and/or specifications may vary in different applications and performance may vary over time. All operating parameters, including typical parameters, must be validated for each customer application by the customer.
18. If you have any queries, please feel free to contact our sales team.

General Note

TT Electronics reserves the right to make changes in product specification without notice or liability. All information is subject to TT Electronics' own data and is considered accurate at time of going to print.

© TT electronics plc

TT Electronics | BI Technologies
A-1445, Jalan Tanjung Api, 25050 Kuantan, Pahang Darul Makmur, Malaysia
Ph: +60 9 565 8888
<https://www.ttelectronics.com/contact-us/>

Issue C 12/2022 Page 7