

7mm Spot Diameter LED

OP207CL



Features:

- SMD Configuration
- Emission Spot Size is 7 mm diameter
- High Power Output with Parallel Rays
- Uniform Distribution
- Emitter Source for Encoder Applications

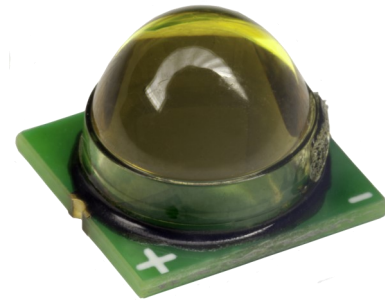

Description:

The **OP207CL** is a high power IR LED designed for encoder applications. The LED features a small foot print, low profile for a 7 mm beam diameter. Radiance is a collimated, narrow beam emission pattern provides on-axis intensity for excellent coupling efficiency for encoder applications.

Applications:

- Linear & Rotary Encoder
- Optical Sensors Switches
- Long Range Light Barriers
- Optical Scanning and Edge Sensing
- Automatic Control Systems

Package Dimensions

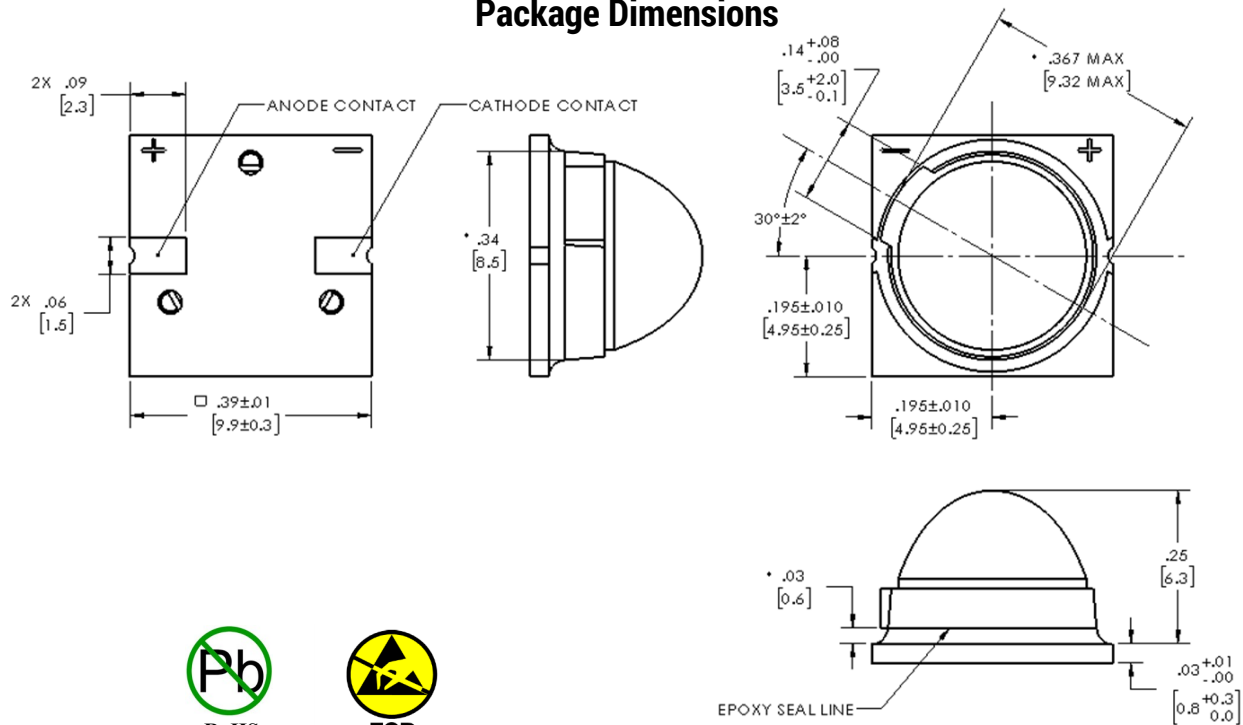

* MEASUREMENTS MADE AT EPOXY SEAL LINE

DIMENSIONS IN INCHES [MM]
TOL $\pm .01$ [.25] UNLESS OTHERWISE STATED

General Note

TT Electronics reserves the right to make changes in product specification without notice or liability. All information is subject to TT Electronics' own data and is considered accurate at time of going to print.

TT Electronics | OPTEK Technology
1645 Wallace Drive, Carrollton, TX 75006 | Ph: +1 972 323 2200
www.ttelectronics.com | sensors@ttelectronics.com

Electrical Specification

Absolute Maximum Ratings ($T_A = 25^\circ\text{C}$ unless otherwise noted)	
Storage Temperature Range	-40°C to $+105^\circ\text{C}$
Operating Temperature Range	-40°C to $+105^\circ\text{C}$
Reverse Voltage	10 V
Continuous Forward Current	100 mA
Power Dissipation ⁽¹⁾	190 mW
Peak Package Body Temperature (T_p) ⁽²⁾	200°C

Electrical Characteristics ($T_A = 25^\circ\text{C}$ unless otherwise noted)						
SYMBOL	PARAMETER	MIN	TYP	MAX	UNITS	TEST CONDITIONS
P_O	Total Output Radiant Power	10.0	-		mW	$I_F = 50\text{ mA}$
Sd	Spot Light Diameter		7.0		mm	$I_F = 50\text{ mA}$, measured at 1.5mm from lens tip
$\frac{1}{2} \theta_{HP}$	Half Intensity Beam Angle		2.25		Degree	$I_F = 50\text{ mA}$
λ_P	Wavelength at Peak Emission	840	855	870	nm	$I_F = 100\text{ mA}$
V_F	Forward Voltage		1.5	1.9	V	$I_F = 50\text{ mA}$
I_R	Reverse Leakage Current		-	10	μA	$V_R = 5.0\text{V}$
t_r, t_f	Rise Time, Fall Time		22		ns	$I_{F(PK)} = 50\text{mA}$, $PW = 10\mu\text{s}$, 10% D.C.

- Notes:
- Derate linearly at 3.42 mW/°C above 60°C.
 - For hand soldering use SAC solder. No clean flux recommended.

Recommended Land Pattern Tolerance $\pm .005$ inches

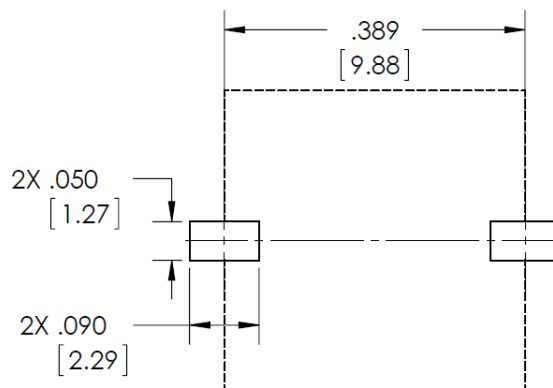

Characteristic Curves (typical)

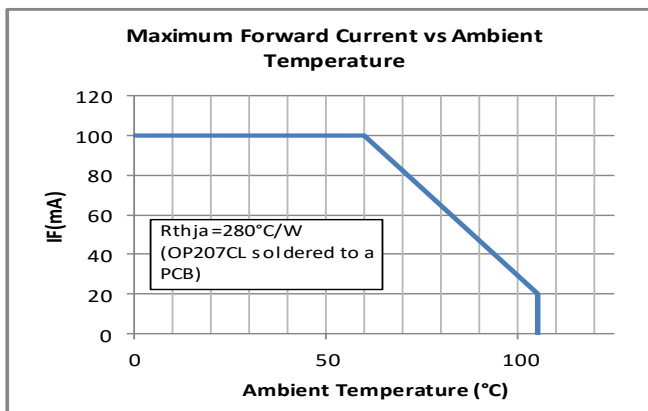
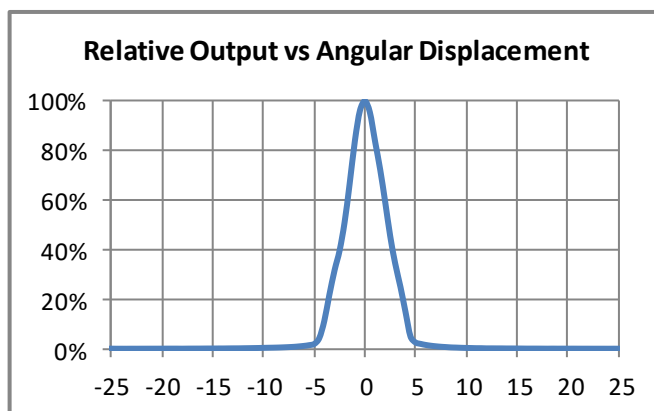
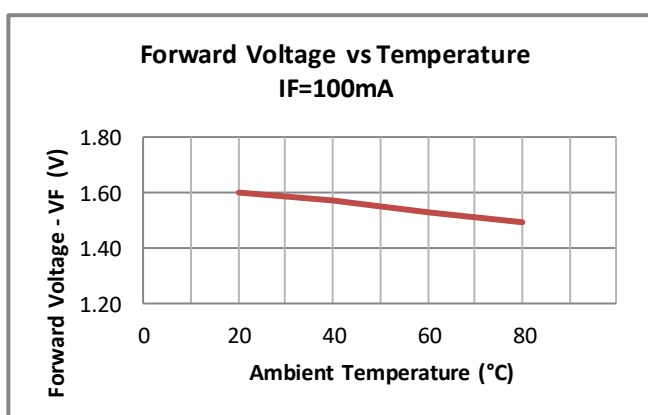
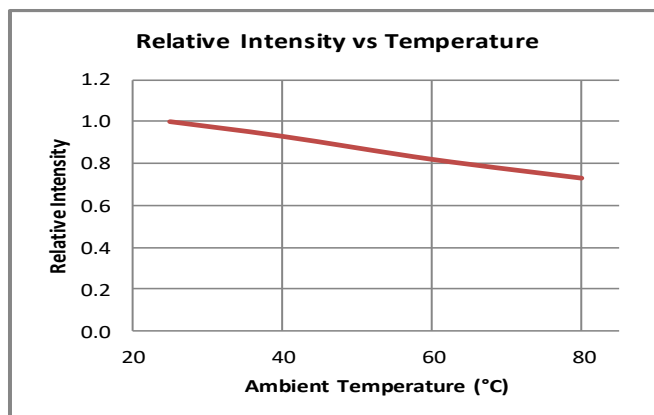
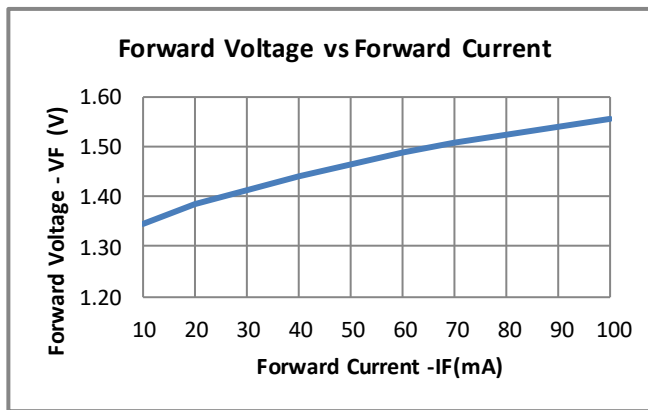
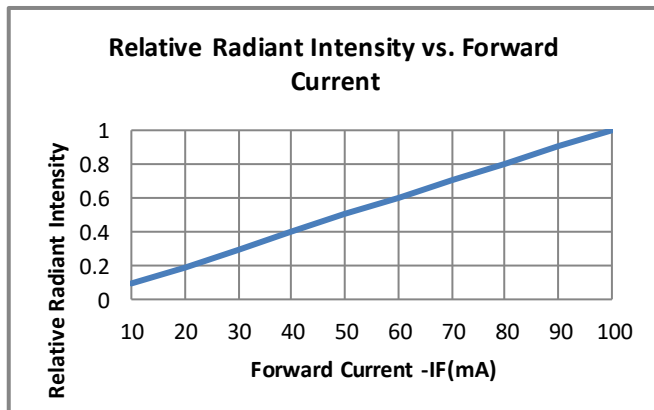

General Note
 TT Electronics reserves the right to make changes in product specification without notice or liability. All information is subject to TT Electronics' own data and is considered accurate at time of going to print.

Characteristic Curves (typical)

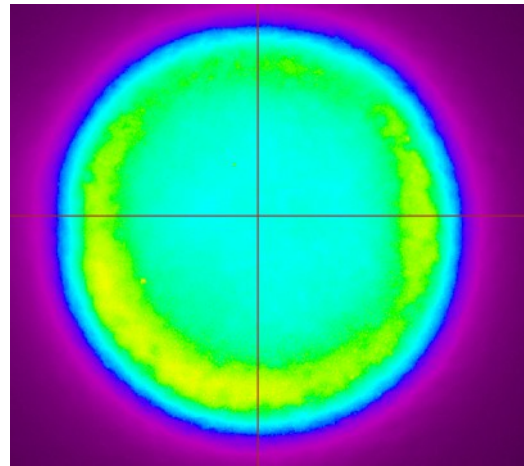
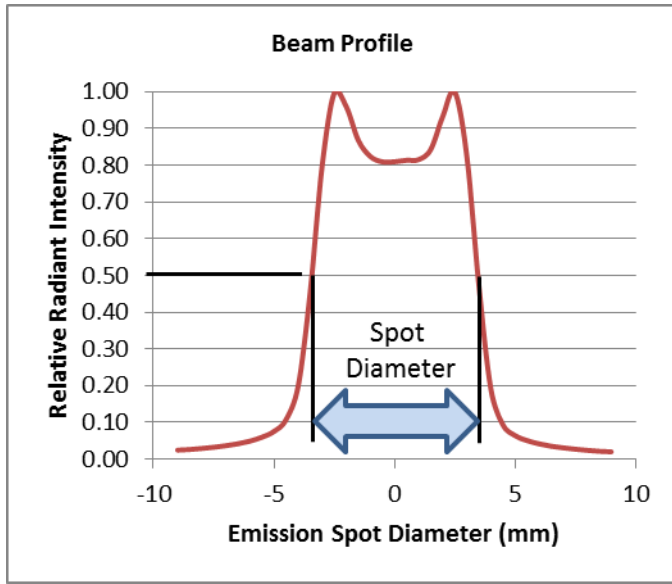

IR Camera Image of Emission Spot

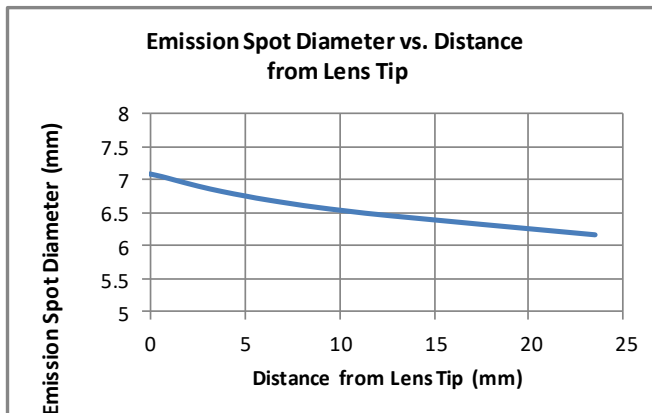

General Note

TT Electronics reserves the right to make changes in product specification without notice or liability. All information is subject to TT Electronics' own data and is considered accurate at time of going to print.