

PN Silicon Photodiode

OP900SL



Features:

- Narrow receiving angle
- Enhanced temperature range
- Ideal for direct mounting to PCBoard
- Fast switching speed
- Linear response vs.irradiance
- Mechanically and spectrally matched to OP123 emitters

Description:

Each **OP900SL** consists of a PN junction silicon photodiode mounted in a miniature glass-lensed hermetically sealed “pill” package. The lensing effect allows an acceptance half-angle of 18°, when measured from the optical axis to the half-power point.

The OP900SL is mechanically and spectrally matched to the OP123 series emitters.

Please refer to Application Bulletins 208 and 210 for additional design information and reliability (degradation) data, and to Application Bulletin 202 for pill-type soldering to PCBoard.

Applications:

- Non-contact reflective object sensor
- Assembly line automation
- Machine automation
- Machine safety
- End of travel sensor
- Door sensor

Ordering Information		
Part Number	Sensor	Viewing Angle
OP900SL	Photodiode	35°

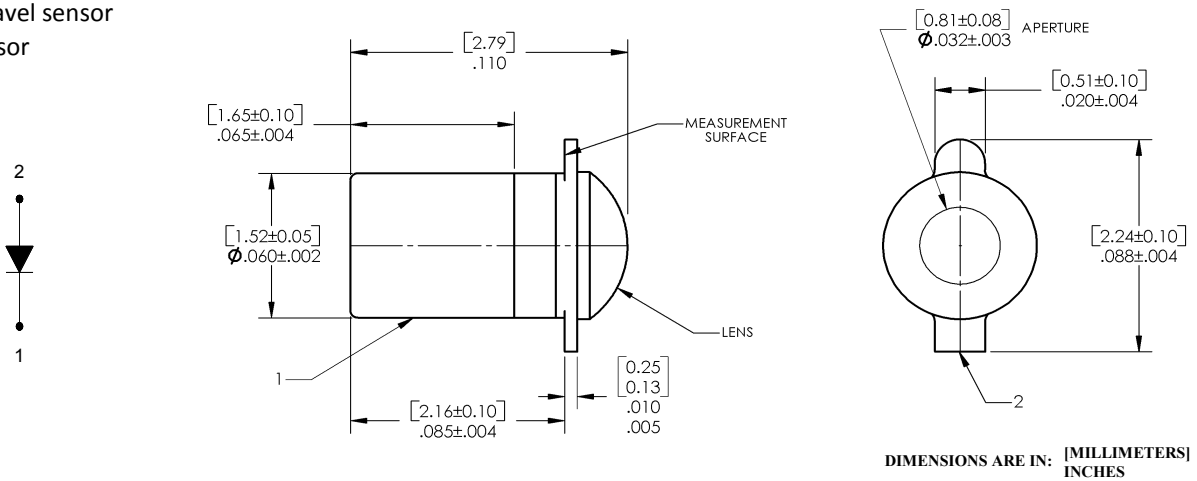

Pin #	Sensor
1	Collector / Cathode
2	Emitter / Anode



RoHS

General Note

TT Electronics reserves the right to make changes in product specification without notice or liability. All information is subject to TT Electronics' own data and is considered accurate at time of going to print.

OPTEK Technology, Inc.
1645 Wallace Drive, Carrollton, TX 75006 | Ph: +1 972 323 2200
www.optekinc.com | www.ttelectronics.com

Electrical Specifications

Absolute Maximum Ratings ($T_A = 25^\circ\text{C}$ unless otherwise noted)	
Reverse Voltage	100 V
Operating Temperature Range	-65°C to $+125^\circ\text{C}$
Storage Temperature Range	-65°C to $+150^\circ\text{C}$
Lead Soldering Temperature [1/16 inch (1.6 mm) from the case for 5 seconds with soldering iron]	$260^\circ\text{C}^{(1)}$
Power Dissipation	$50\text{ mW}^{(2)}$

Electrical Characteristics ($T_A = 25^\circ\text{C}$ unless otherwise noted)						
SYMBOL	PARAMETER	MIN	TYP	MAX	UNITS	TEST CONDITIONS
I_L	Light Current	8	14	-	μA	$V_R = 10\text{ V}$, $E_E = 20\text{ mW/cm}^2$ ⁽³⁾⁽⁴⁾
I_D	Dark Current	-	-	10	nA	$V_R = 10\text{ V}$, $E_E = 0$ ⁽³⁾
$V_{(BR)R}$	Reverse Voltage Breakdown	100	150	-	V	$I_R = 100\ \mu\text{A}$
t_r	Rise Time	-	100	-	ns	$V_R = 50\text{ V}$, $I_L = 8\ \mu\text{A}$, $R_L = 1\text{ k}\Omega$ (see test circuit)
t_f	Fall Time	-	100	-		

Notes:

- (1) RMA flux is recommended. Duration can be extended to 10 seconds maximum when flow soldering.
- (2) Derate linearly $0.5\text{ mW}/^\circ\text{C}$ above 25°C .
- (3) Junction temperature maintained at 25°C .
- (4) Light source is an unfiltered tungsten bulb operating at $CT = 2870\text{ K}$ or equivalent infrared source..

General Note

TT Electronics reserves the right to make changes in product specification without notice or liability. All information is subject to TT Electronics' own data and is considered accurate at time of going to print.

OPTEK Technology, Inc.
1645 Wallace Drive, Carrollton, TX 75006 | Ph: +1 972 323 2200
www.optekinc.com | www.ttelectronics.com

PN Silicon Photodiode

OP900SL



Performance

OP900SL

Typical Spectral Response

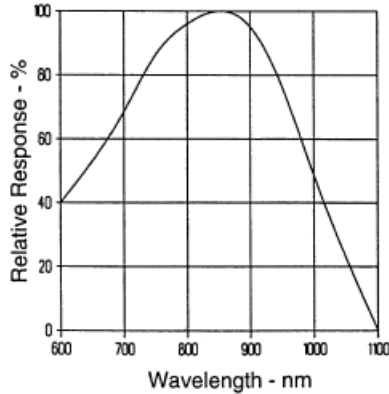

Coupling Characteristics of OP123 and OP900SL

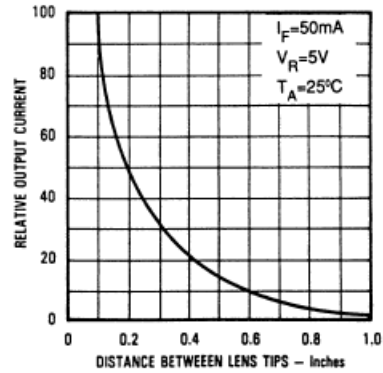

Dark Current vs. Ambient Temperature

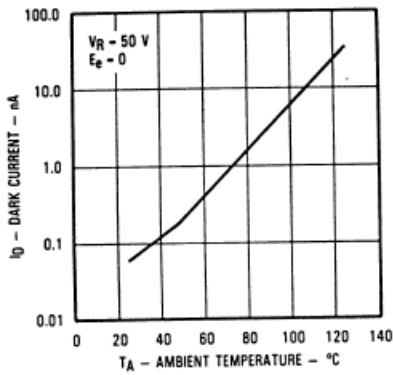

Normalized Light Current vs. Ambient Temperature

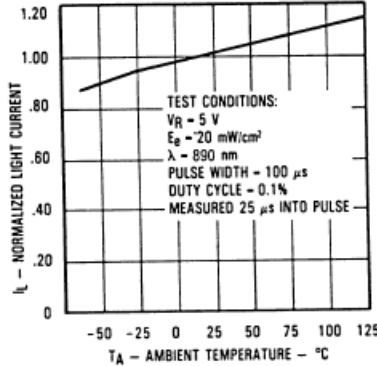

Total Capacitance vs. Reverse Voltage

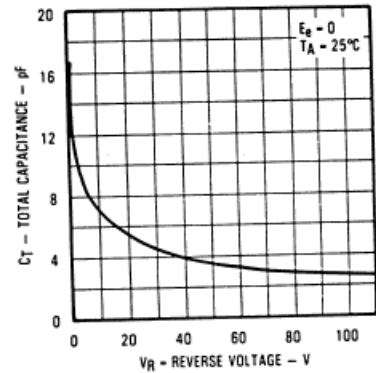

Light Current vs. Irradiance

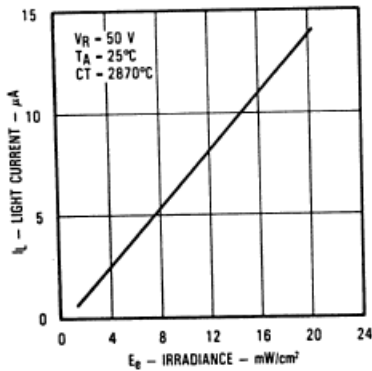

Switching Time Test Circuit

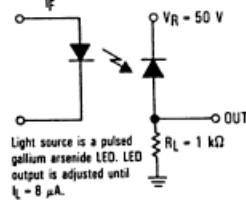

Light Current vs. Angular Displacement

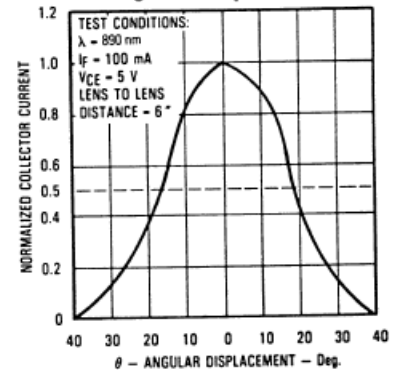

General Note

TT Electronics reserves the right to make changes in product specification without notice or liability. All information is subject to TT Electronics' own data and is considered accurate at time of going to print.

OPTEK Technology, Inc.
1645 Wallace Drive, Carrollton, TX 75006 | Ph: +1 972 323 2200
www.optekinc.com | www.ttelectronics.com