

PIN Silicon Photodiode

OP950 Series



Features:

- Epoxy package
- Linear response vs. irradiance
- Fast switching time
- Choice of wide or extra wide receiving angle
- Side-looker package
- Small package style ideal for space-limited applications

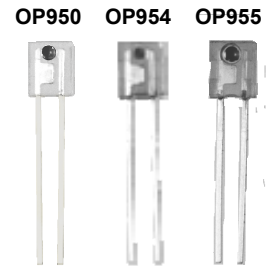

Description:

Each **OP950**, **OP954** and **OP955** device consists of a PIN silicon photodiode molded in an epoxy package that allows spectral response from visible to infrared light wavelengths. The side-looking package is designed for easy PCBoard mounting and space-limited applications.

The **OP950** has a 95° *wide* receiving angle that provides relatively even reception over a large area and is mechanically and spectrally matched to OPTEK's GaAs and GaAlAs series of infrared emitting diodes.

The **OP954** has a 128° *very wide* receiving angle that provides relatively even reception over a large area.

The **OP955** has a 95° *wide* receiving angle with a recessed lens, which allows an acceptance half-angle of 45° when measured from the optical axis to the half power point.

Both **OP954** and **OP955** components are 100% production tested, using infrared light for close correlation with OPTEK's GaAs and GaAlAs emitters.

Please refer to Application Bulletins 208 and 210 for additional design information and reliability (degradation) data.

Applications:

- Non-contact reflective object sensor
- Assembly line automation
- Machine automation
- Machine safety
- End of travel sensor
- Door sensor

Ordering Information			
Part Number	Sensor	Viewing Angle	Lead Length
OP950	Photodiode	95°	50"
OP954		128°	
OP955		95°	



RoHS

General Note
TT Electronics reserves the right to make changes in product specification without notice or liability. All information is subject to TT Electronics' own data and is considered accurate at time of going to print.

OPTEK Technology, Inc.
1645 Wallace Drive, Carrollton, TX 75006 | Ph: +1 972 323 2200
www.optekinc.com | www.ttelectronics.com

PIN Silicon Photodiode

OP950 Series



OP950 Sidelooker Lens

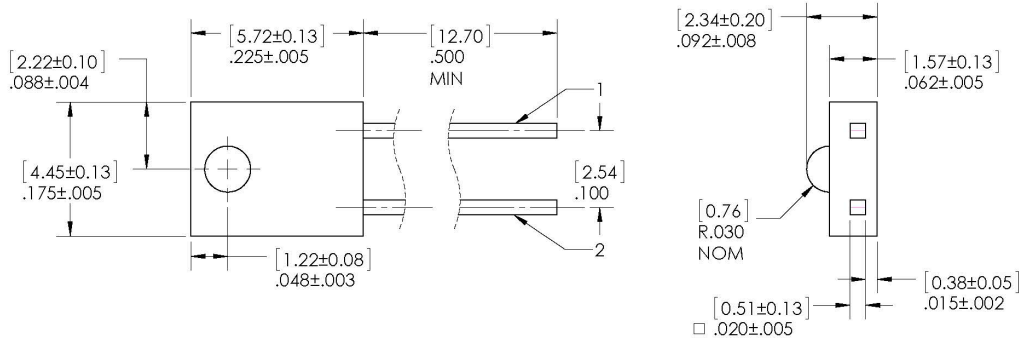

DIMENSIONS ARE IN: [MILLIMETERS]
INCHES

OP950



Pin #	Diode
1	Anode
2	Cathode

OP954 Sidelooker Lens

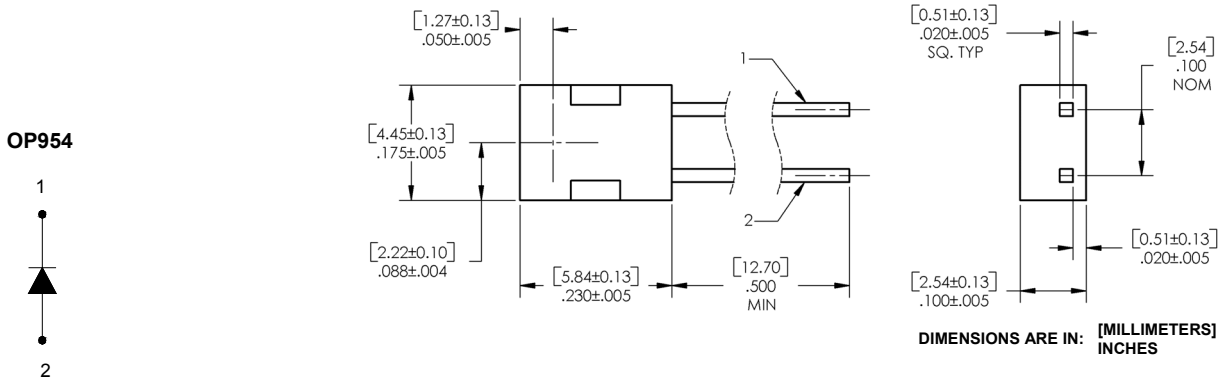

OP954



DIMENSIONS ARE IN: [MILLIMETERS]
INCHES

Pin #	Diode
1	Cathode
2	Anode

OP954 - CONTAINS POLYSULFONE

To avoid stress cracking, we suggest using ND Industries' **Vibra-Tite** for thread-locking. **Vibra-Tite** evaporates fast without causing structural failure in OPTEK'S molded plastics.

General Note
TT Electronics reserves the right to make changes in product specification without notice or liability. All information is subject to TT Electronics' own data and is considered accurate at time of going to print.

OPTEK Technology, Inc.
1645 Wallace Drive, Carrollton, TX 75006 | Ph: +1 972 323 2200
www.optekinc.com | www.ttelectronics.com

PIN Silicon Photodiode

OP950 Series



OP955 Sidelooker Recessed Lens

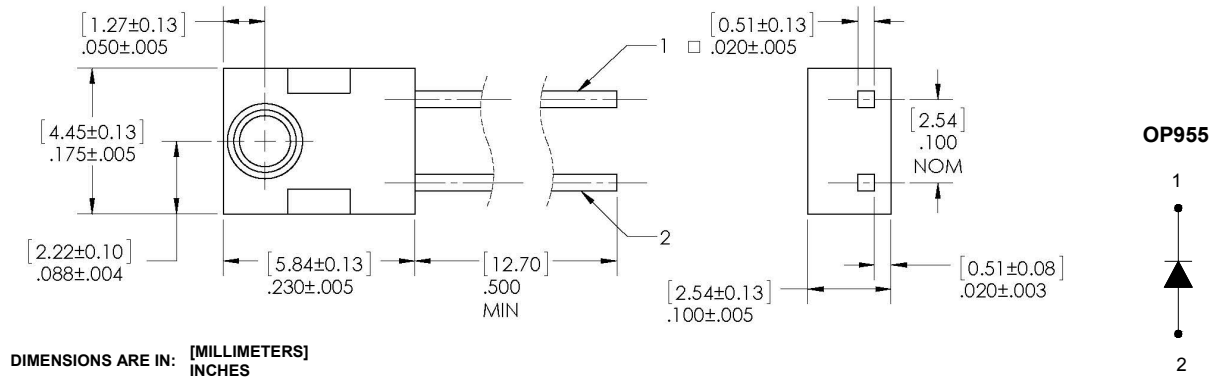

Pin #	Diode
1	Cathode
2	Anode

OP955

OP955 - CONTAINS POLYSULFONE
 To avoid stress cracking, we suggest using ND Industries' **Vibra-Tite** for thread-locking. **Vibra-Tite** evaporates fast without causing structural failure in OPTEK'S molded plastics.

General Note
 TT Electronics reserves the right to make changes in product specification without notice or liability. All information is subject to TT Electronics' own data and is considered accurate at time of going to print.

OPTEK Technology, Inc.
 1645 Wallace Drive, Carrollton, TX 75006 | Ph: +1 972 323 2200
 www.optekinc.com | www.ttelectronics.com

Electrical Specifications

Absolute Maximum Ratings ($T_A = 25^\circ\text{C}$ unless otherwise noted)	
Reverse Breakdown Voltage	60 V
Storage & Operating Temperature Range	-40° C to +100° C
Lead Soldering Temperature [1/16 inch (1.6 mm) from the case for 5 sec. with soldering iron]	260° C ⁽¹⁾
Reverse Breakdown Voltage	60 V
Power Dissipation	100 mW ⁽²⁾

Electrical Characteristics ($T_A = 25^\circ\text{C}$ unless otherwise noted)						
SYMBOL	PARAMETER	MIN	TYP	MAX	UNITS	TEST CONDITIONS
I_L	Reverse Light Current OP950, OP955 OP954	8	-	18	μA	$V_R = 5\text{ V}, E_E = 1\text{ mW/cm}^2$ ⁽³⁾
		3.5	-	8		
I_D	Reverse Dark Current	-	1	60	nA	$V_R = 30\text{ V}, E_E = 0$ ⁽⁴⁾
$V_{(BR)}$	Reverse Breakdown Voltage	60	-	-	V	$I_R = 100\ \mu\text{A}$
V_F	Forward Voltage	-	-	1.2	V	$I_F = 1\text{ mA}$
C_T	Total Capacitance	-	4	-	pF	$V_R = 20\text{ V}, E_E = 0, f = 1.0\text{ MHz}$
t_r	Rise Time	-	5	-	ns	$V_R = 20\text{ V}, \lambda = 850\text{ nm}, R_L = 50\ \Omega$
t_f	Fall Time	-	5	-		

Notes:

- (1) RMA flux is recommended. Duration can be extended to 10 seconds maximum when flow soldering. A maximum of 20 grams force may be applied to leads when soldering.
- (2) Derate linearly 1.67 mW/° C above 25° C.
- (3) The light source is an unfiltered GaAs LED with a peak emission wavelength of 935 nm and a radiometric intensity level which varies less than 10% over the entire lens surface of the photodiode being tested.
- (4) Calculate the typical dark current in nA using the formula $I_D = 10^{(0.042T_A - 1.5)}$ where T_A is ambient temperature in °C.

PIN Silicon Photodiode

OP950 Series



Performance

OP950 Series

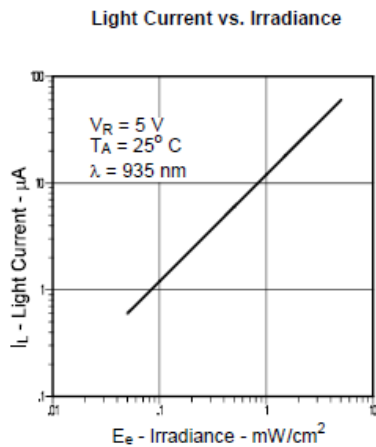
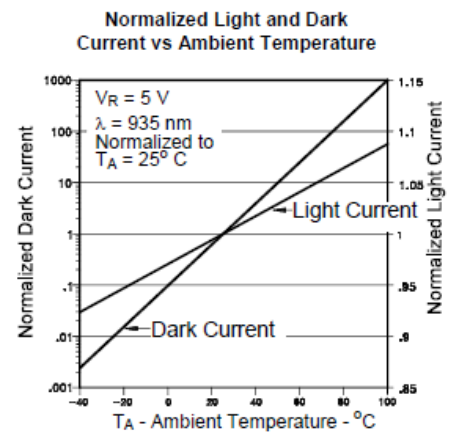
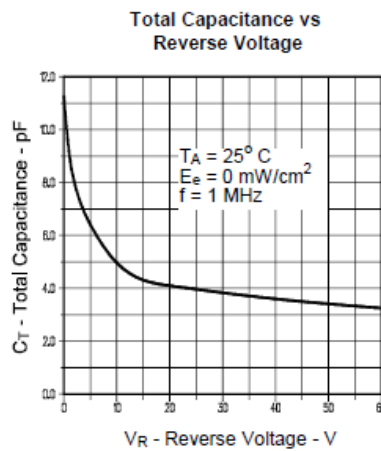
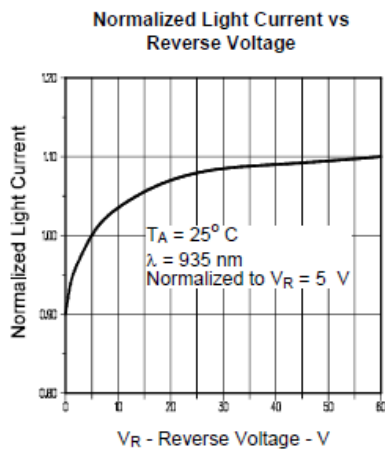
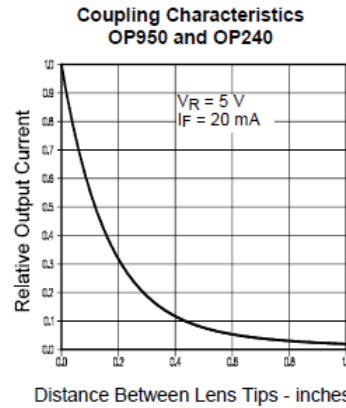
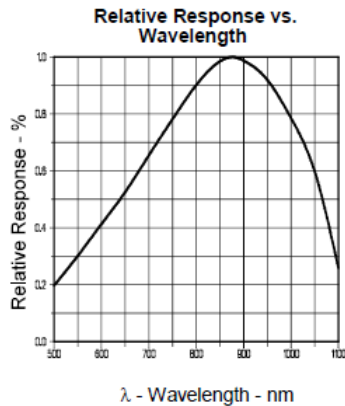

Switching Time Test Circuit

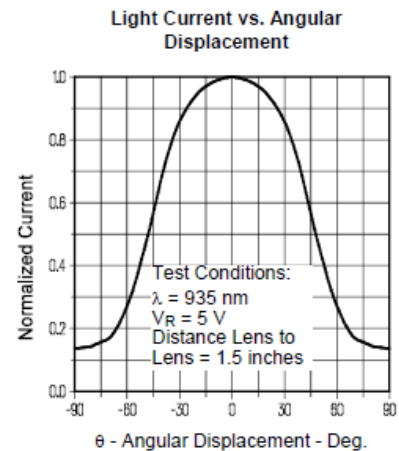
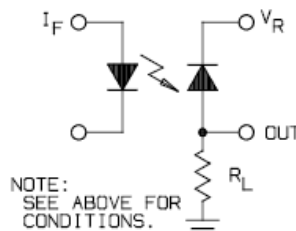

General Note
TT Electronics reserves the right to make changes in product specification without notice or liability. All information is subject to TT Electronics' own data and is considered accurate at time of going to print.

OPTEK Technology, Inc.
1645 Wallace Drive, Carrollton, TX 75006 | Ph: +1 972 323 2200
www.optekinc.com | www.ttelectronics.com