

High Voltage / High Speed Opto-Isolator

OPI1268S

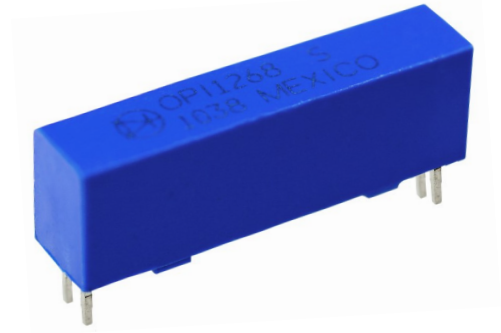

Features:

- 20kV dc Isolation
- 2 Mbit/s transfer rate
- $t_{PHL}-t_{PLH} \leq 50$ ns typical
- Creepage path: 24 mm
- TTL Compatible
- 6 Axis / 10G_{RMS} load rating

Certifications:

- UL File E58730
- Vde File 40031798
- EN 60079-0:2012/A11:2013
EN60079-11:2012 (IEC 60079-11:2011 Edition 6)
- IP65 Rated
- ATEX Certification Exia IIc Ga

Description:

The **OPI1268S** is a high voltage isolator with a digital output that is capable of high speed data transmission. The input of the OPI1268 consists of a high-efficiency GaAlAs LED with a peak wavelength of 850 nm, which is optically coupled to the output optical IC. A photologic device in the output IC detects the incoming modulated light and converts it to a proportionate current. This current is fed into a high-gain linear amplifier which is temperature, current and voltage compensated. The result is a highly stable digital output with an open collector inverter configuration. This device produces DC and AC voltage isolation between the input and output circuitry while providing TTL signal integrity.

Applications:

- Transportation Systems
- PC Board Power Systems
- Hybrid Vehicle Systems
- Medical Systems
- Control Systems

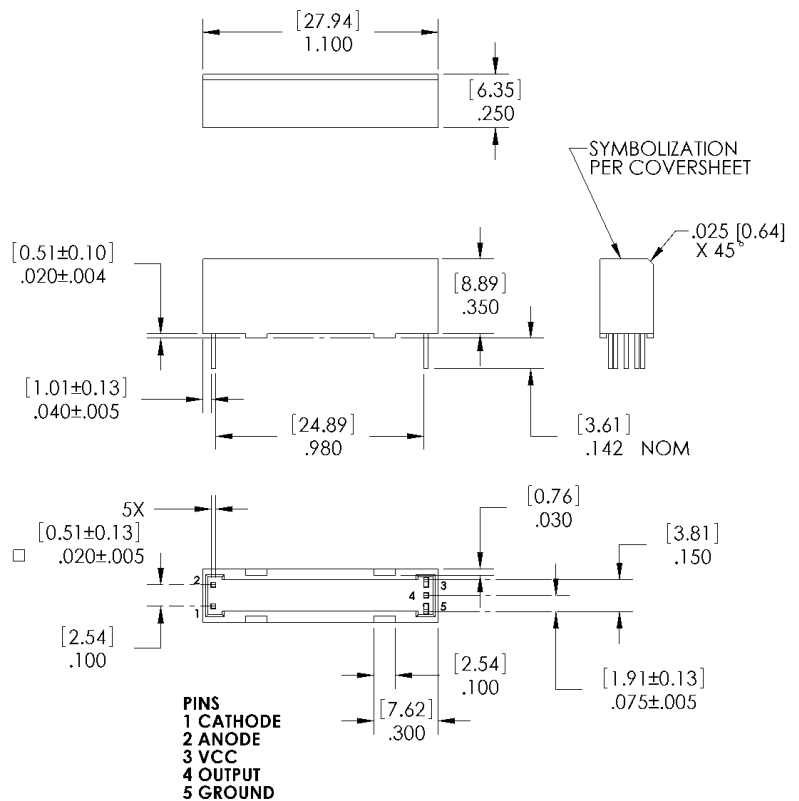

NOTE:

1. DIMENSIONS ARE $\pm .010$ [.25] UNLESS OTHERWISE NOTED.
2. DIMENSIONS ARE IN INCHES [MM].

Ordering Information								
Part Number	LED Peak Wavelength	Sensor Photologic®	Isolation Voltage (kV)DC	t_{PLH} / t_{PHL} Max (ns)	I_F (mA) Typ / Max	V_{CE} (V) Max	Lead Length (mm)	Lead Spacing (mm)
OPI1268S	850 nm	Open Collector	20	100	10 / 50	18	3.6	2.0



Pb-Free
(RoHS)

General Note

TT Electronics reserves the right to make changes in product specification without notice or liability. All information is subject to TT Electronics' own data and is considered accurate at time of going to print.

TT Electronics | OPTEK Technology
1645 Wallace Drive, Carrollton, TX 75006 | Ph: +1 972 323 2200
www.ttelectronics.com | sensors@ttelectronics.com

Absolute Maximum Ratings ($T_A = 25^\circ\text{C}$ unless otherwise noted)

Storage Temperature	-50° C to +100° C
Operating Temperature	-50° C to +100° C
Input-to-Output Isolation Voltage ⁽²⁾	20 kVDC
Lead Soldering Temperature (1/16" (1.6 mm) from case for 5 seconds with soldering iron) ⁽³⁾	260° C
Input Diode	
Continuous Forward Current	30 mA
Peak Forward current (1 μs pulse width, 300 pps)	3.0 A
Reverse Voltage	3.0 V
Power Dissipation ⁽¹⁾	100 mW
Output IC	
Maximum Supply Voltage	7 V
Power Dissipation ⁽⁴⁾	40 mW
Maximum Output Voltage	18 V
Maximum Output Current	25 mA

Electrical Characteristics ($T_A = 0^\circ\text{C}$ to 70°C unless otherwise noted)

SYMBOL	PARAMETER	MIN	TYP	MAX	UNITS	TEST CONDITIONS
Input Diode						
V_F	Forward Voltage	-	1.4	1.8	V	$I_F = 20\text{ mA}$
I_R	Reverse Current	-	0.1	100	μA	$V_R = 2.0\text{ V}$
Output IC ($V_{CC} = 4.5\text{ V}$ to 5.25 V) (See OPL550 for additional information—for reference only.)						
I_{OH}	High Level Output Current	-	0.20	25	μA	$I_F = 0.0\text{ mA}$, $V_{OH} = 18.0\text{ V}$, $V_{CC} = 5.25\text{ V}$
V_{OL}	Low Level Output Voltage	-	0.35	0.55	V	$I_F = 10.0\text{ mA}$, $I_{OL} = 8.0\text{ mA}$, $V_{CC} = 4.5\text{ V}$
I_{CCH}	High Level Supply Current	-	5.5	7	mA	$I_F = 0$, $V_{CC} = 5.25\text{ V}$
I_{CCL}	Low Level Supply Current	-	7.5	10		$I_F = 10.0\text{ mA}$, $V_{CC} = 5.25\text{ V}$
Coupled Characteristics ($V_{CC} = 5\text{ V}$, $I_F = 30\text{ mA}$, $R_L = 560\Omega$)						
C_{IO}	Coupling Capacitance	-	-	2	pF	Input and output leads shorted.
t_{PLH}	Propagation Delay to Low Output Level	-	50	100	ns	See Figure 1
t_{PHL}	Propagation Delay to High Output Level	-	50	100		
I_{ISO}	Isolation Leakage Current ⁽⁵⁾	-	-	20	μA	$V_{ISO} = 19.2\text{ kV dc}$
I_{F+}	LED Positive Going Threshold Current	0.8	1.7	5.0	mA	$V_{CC} = 5\text{ V}$, $I_{OL} = 8.0\text{ mA}$
dv/dt	Voltage Spike Immunity		30		kV/ μs	

Notes:

- Derate LED linearly 1.33 mW/ $^\circ\text{C}$ above 25°C .
- UL recognition is for 16kV dc for one minute.
- RMA flux is recommended. The duration can be extended to 10 seconds maximum when flow soldering.
- Derate linearly 0.54m W/ $^\circ\text{C}$.
- Measured with input leads shorted together and output leads shorted together in air with a maximum relative humidity of 50%.

General Note

TT Electronics reserves the right to make changes in product specification without notice or liability. All information is subject to TT Electronics' own data and is considered accurate at time of going to print.

TT Electronics | OPTEK Technology
1645 Wallace Drive, Carrollton, TX 75006 | Ph: +1 972 323 2200
www.ttelectronics.com | sensors@ttelectronics.com

Typical Performance Curves

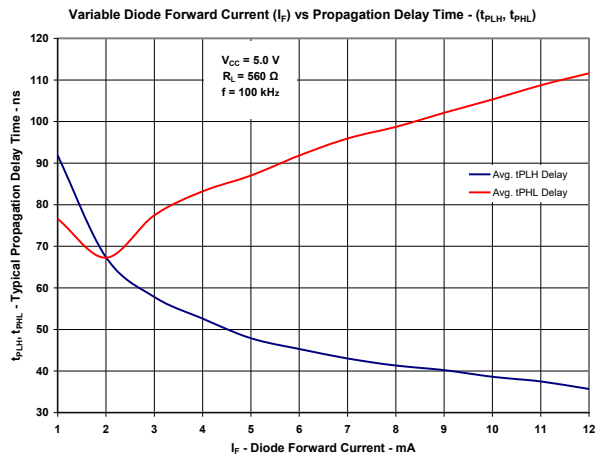
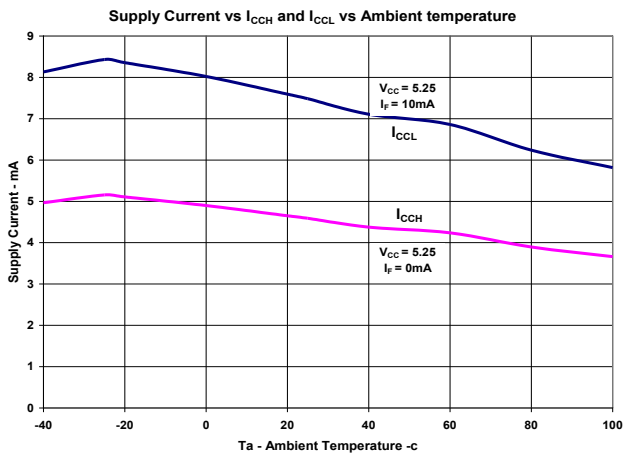
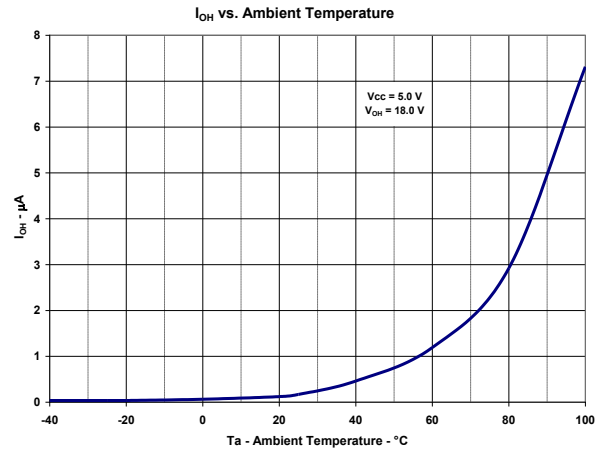
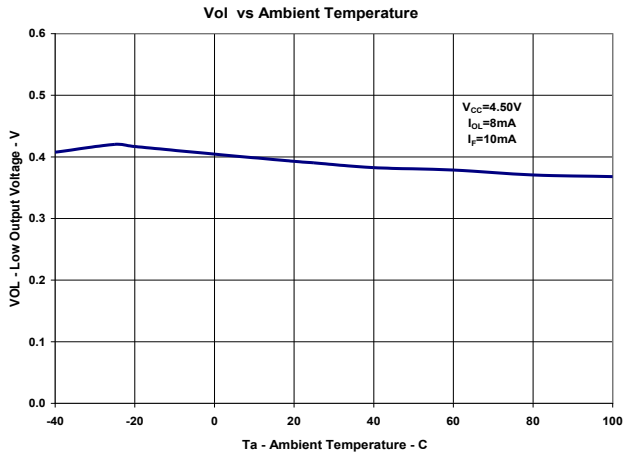
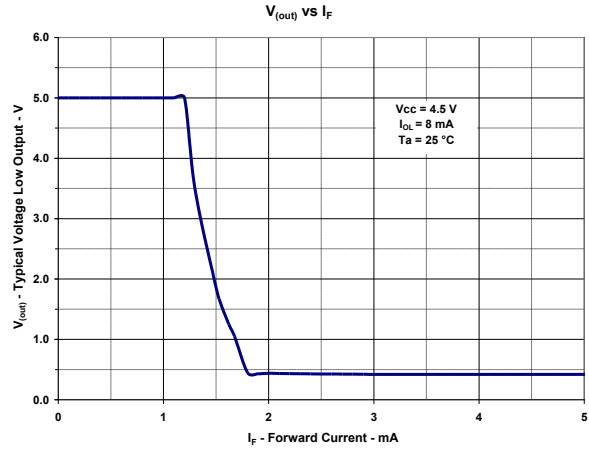
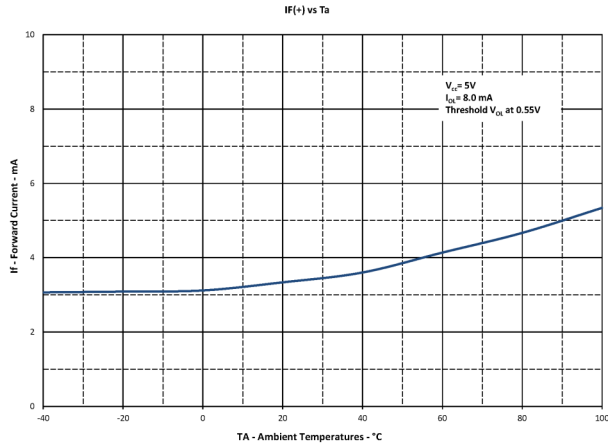

General Note

TT Electronics reserves the right to make changes in product specification without notice or liability. All information is subject to TT Electronics' own data and is considered accurate at time of going to print.

CIRCUIT VALUES

Condition #1: $V_{CC} = 5.0V$, $I_F = 30mA$, $R_L = 560 \text{ Ohms}$

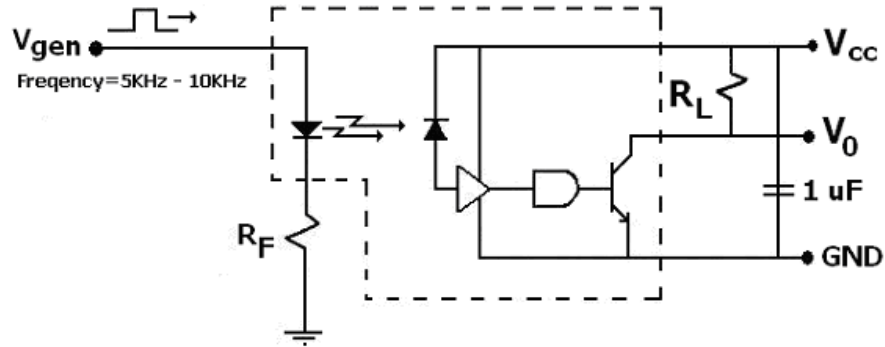
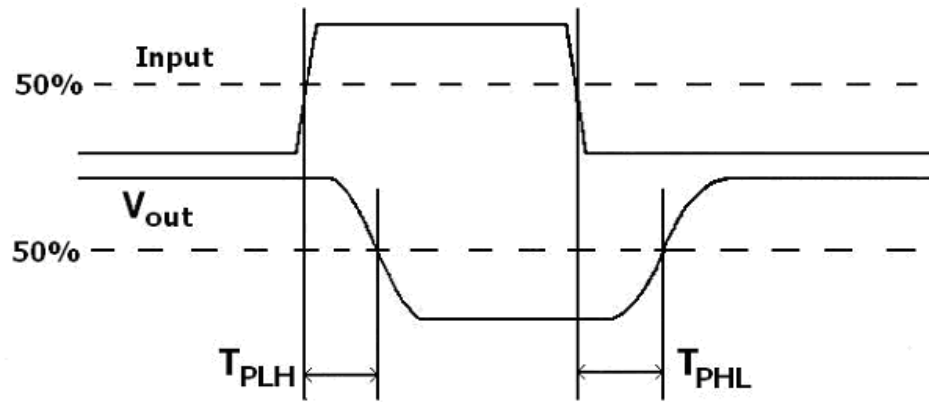

Figure 1



General Note

TT Electronics reserves the right to make changes in product specification without notice or liability. All information is subject to TT Electronics' own data and is considered accurate at time of going to print.

TT Electronics | OPTEK Technology
1645 Wallace Drive, Carrollton, TX 75006 | Ph: +1 972 323 2200
www.ttelectronics.com | sensors@ttelectronics.com