

High Voltage Application Note

Resistors

BI Technologies IRC Welwyn



Application Note

Resistors for High Voltage Applications

TT Electronics offers one of the most diverse ranges of high voltage resistors. Across the HV range from 1 to 100kV products are available which provide safety in discharge, reliability in balancing and accuracy in measurement. For designers requiring a resistor with parameters outside of this range, bespoke solutions for specific applications may be supplied.

From commercial thick-film & precision high voltage devices to bleeders, dividers and ultra high resistance values ($100T$ or $10^{14}\Omega$), products are supplied to key commercial & military standards. RoHS compliant Pb-free finish and SnPb finish are both available across most product families. Because of its ability to maintain good stability of resistivity in the presence of high voltage stress, the technology normally used for compact high voltage resistors is thick-film.

TT Electronics' companies have been leaders in thick-film product development since the 1960s and can now offer a full range of component styles including compact SMD chips, conventional axial through-hole and space-saving single-in-line (SIL) radial format.

This Application Note gives data, calculations and typical products for use in high voltage circuits. It should be read in conjunction with the full datasheets for each product referenced.

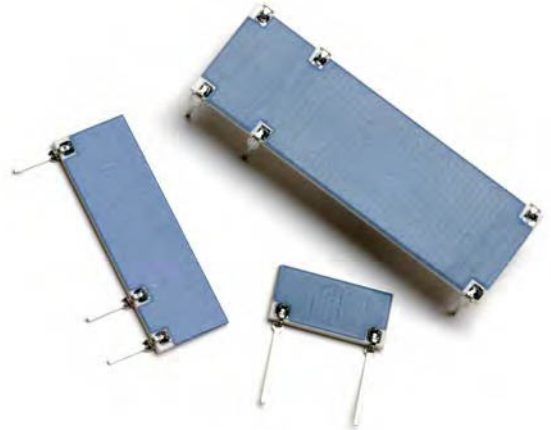

- EN60065 safety bleeders
- Voltage balancing resistors
- Resistive voltage dividers
- LEVs up to 100kV
- Ohmic values to $100T\Omega$
- Compatibility with oil of SF₆ filled assemblies
- MIL-R-49462 approval
- X-ray PSU • AED • Electron Microscope • E-beam Welder
- Electrostatic Precipitator • Air Ioniser • Photomultiplier
- Gas Detector • Lightning Ballast • IR Tester • EL Backlight
- PFC • UPS • ESD Protection • Seismic Monitor • Paint Spray

For our full product portfolio, in-house & local design support / distribution partners, visit: www.ttelectronics.com/resistors

Application Note

High Voltage Bleeders

Bleed resistors are used to discharge capacitors to safe voltage levels after power is removed. A bleed resistor may be either switched across the capacitor for rapid discharge without quiescent dissipation

(Figure 1), or permanently connected for high reliability and low cost (Figure 2). In the latter case there is a trade-off between the time to reach safe discharge and the quiescent power loss.

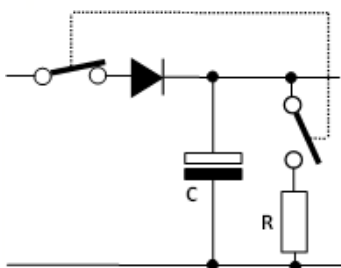

Figure 1
Switched bleed resistor

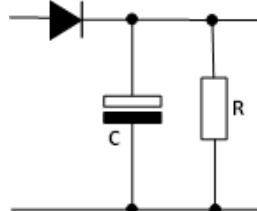

Figure 2
Permanent bleed resistor

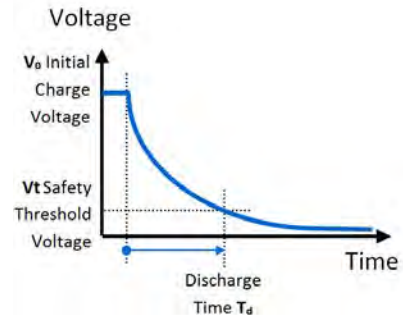

Figure 3
Exponential discharge

Selecting a maximum suitable ohmic value is achieved from an exponential discharge calculation (Figure 3):

$$R_{max} = \frac{-T_d}{C \cdot \ln(V_t / V_0)}$$

where T_d is discharge time, C is capacitance value assuming maximum positive tolerance, V_t is safety threshold voltage and V_0 is the initial voltage. The closest standard value below R_{max} should be used.

For a selected value R , the initial power is given by

$$P_0 = V_0^2 / R$$

For a switched bleeder this is the peak power. For a permanently connected bleeder it is the continuous dissipation, and the resistor chosen must be rated accordingly.

Capacitor Discharge Calculator is an on-line tool for safety-related bleed resistor selection which is available at:

<http://www.ttelectronics.com/resistors> under the Tools tab.

In bleeder applications precision is generally unimportant and 5% tolerance can be used. However, safety is often critical, and in mains (line) connected applications a suitable safety approval such as EN60065 should be called up. This standard ensures that the component will withstand the lightning or switching induced surges found on power lines.

Example 1

A high voltage rail with a maximum of 1kV has a $1\mu\text{F} \pm 20\%$ reservoir. This needs to be discharged below 50V within 10s of switch-off.

This can just be achieved with a bleed value of 2M7, but to allow for a 5% tolerance, 2M2 is a better choice. With this the maximum time to discharge is 8.3s and the power dissipation at full voltage is 0.45W.

A suitable solution is VRW37-2M2J, rated at 0.5W and 3.5kV.

Example Products

VRW37

- Meets EN60065 requirements
- 3.5kV rating
- 10kV pulse rating

CDR

- Ratings to 30kV
- Non-contaminating, for use inside oil filled capacitors

CGH

- Value range to 2kV
- Ratings 750V to 20kV
- Power to 5W

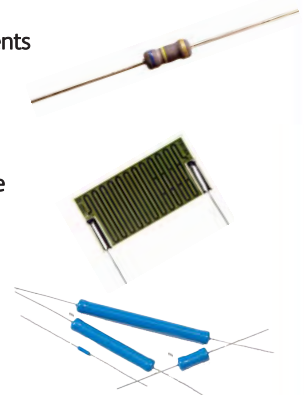

Application Note

Voltage Balancing Resistors

All aluminium electrolytic capacitors exhibit a leakage current when a DC voltage is connected across them. This may be modelled by a leakage resistance connected in parallel with the capacitor. This resistance is non-linear, that is, its value is a function of the applied voltage. Furthermore, the value is poorly defined, having a large degree of variation from one capacitor to another.

When building a capacitive reservoir for a high voltage DC bus it is common to use a series combination of two capacitors, each rated at half the bus voltage, as shown in Figure 4. If the capacitors are identical, the bus voltage will be shared equally between them. However, in practice the leakage resistances will differ, leading to uneven sharing and potential voltage overload on the capacitor with the higher leakage resistance. In other words, if $R_{la}(V_a) < R_{lb}(V_b)$ then the result will be $V_b > V_a$ and possible failure of C_b .

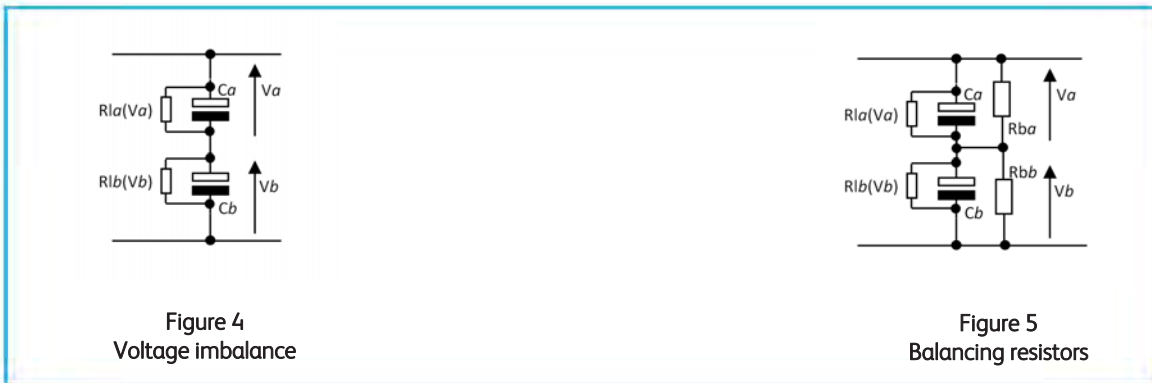

Figure 4
Voltage imbalance

Figure 5
Balancing resistors

The solution is to use balancing resistors as shown in Figure 5. These are high value resistors rated at the appropriate voltage and matched in value to within a few percent. The value needs to be as high as possible to minimise power dissipation, but is generally chosen so that it is no more than 10% of the lowest value of leakage resistance at the rated voltage of the capacitor, V . That is, $R_{ba} \leq R_{la}(V_r)/10$. By this means the effect of the unbalanced internal capacitor leakage resistances is swamped by that of the balancing resistors, and the voltages are approximately equalised, so $V_a \approx V_b$.

configurations which may be used; either a bank of parallel connected capacitors may be balanced by a single pair of balancing resistors (Figure 6), or each pair of capacitors may be provided with its own pair of balancing resistors (Figure 7). Although clearly offering a lower component count, the first option suffers from a significantly lower reliability. This is because the effect of a short circuit failure of any one capacitor in the bank is that full bus voltage appears across the capacitors in the opposite half of the circuit. The circuit failure rate for n capacitors with a FIT of F is therefore $n.F$. The second option offers a superior reliability as a capacitor short failure will only cause failure of its twin. Depending on the acceptable level of degradation in smoothing, the FIT rate may therefore be $<F$.

In order to raise the total capacitance value, two or more pairs of capacitors may be connected in parallel. There are two

Figure 6
Parallel capacitors

Figure 7
High reliability balancing of parallel capacitors

Example Products

WPYP

- Direct Mount
- Vibration resistant
- Rating to 13W
- High overload wirewound

HVP

- Ratings to 20kV
- Minimal footprint
- Compact construction
- High value thick-film
- Powder coated option

Application Note

Voltage Dividers

A common application for high voltage resistors is in voltage dividers for the measurement or control of high voltage rails. Figure 8 shows a typical application in which the output of a high voltage power supply is scaled down and fed back for regulation purposes. Assuming that the input impedance of the buffer is much greater than R1 the loading on the divider is negligible, so the voltage ratio is simply given by:

$$V_i / V_o = \frac{(R_1 + R_2)}{R_1} = 1 + R_2 / R_1$$

It should be noted that the voltage ratio is not the same as the resistance ratio R2 / R1 but is offset by one. Therefore, for example, for a voltage ratio of 1000:1 it is necessary to define a resistance ratio of 999:1. For a discrete resistor design it is preferable to select standard values, and some examples for decade voltage ratios are given in Table 1.

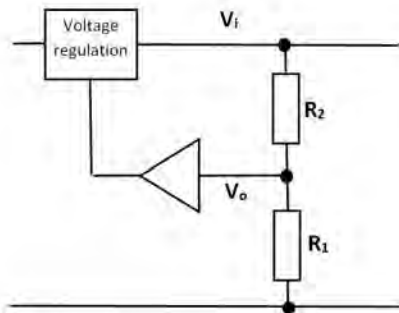

Figure 8
Voltage Divider

Table 1 Decade Voltage Ratios using Standard Values

Target Voltage Ratio	R2 / R1	R1 (E24/96)	R2 (E12)	Actual Voltage Ratio	Nominal Error
10:1	9	9K1	82K	10.01	0.1%
100:1	99	4K75	470K	99.95	-0.05%
1000:1	999	1K0	1M0	1001	+0.1%
1000:1	999	6K81	6M8	999.5	-0.05%
10000:1	9999	1K0	10M	10001	+0.01%

Having selected nominal values, the next consideration is the tolerance needed. The tolerance in resistance ratio is simply the sum of the individual resistance tolerances. These are not necessarily the same; often it is most economical to select a tighter tolerance on the low voltage part. For example, high voltage R2 at 1% and low voltage R1 at 0.1% gives a resistance ratio tolerance of 1.1%. The conversion of this to voltage ratio tolerance is shown in Figure 9, but for ratios above 50:1 they are effectively the same. Suitable precision low voltage parts are RC Series (through hole) and PCF Series (SMD chip).

For high precision applications the sources of error to be considered include finite loading of the divider by the buffer amplifier input, voltage coefficient of resistance (VCR) and temperature coefficient of resistance (TCR). The VCR is always negative and approximately linear over a limited voltage range and so may be compensated for to some extent. The effect of TCR, and, indeed, of tolerance, may be reduced by selecting matched sets or integrated dividers with a specified ratio tolerance and TCR tracking

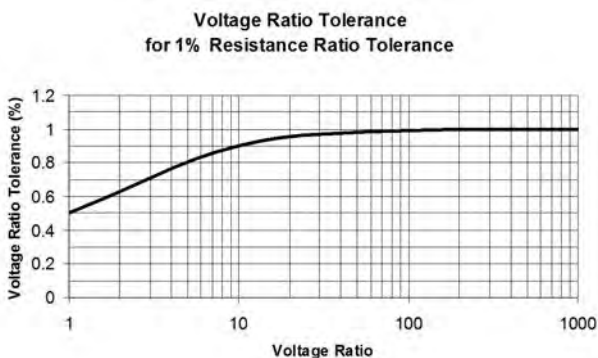

Figure 9

Example Products

T

- To 50kV in air or 100kV in c^l
- Power to 10W
- Matched sets available
- 25ppm/°C available
- Low VCR

HVC

- Compact solution
- 3kV in 2512 size
- Low assembly cost

HVD

- Ratings to 30kV
- Small footprint
- Integrated divider
- Ratio tolerance specified
- Powder Coated Option

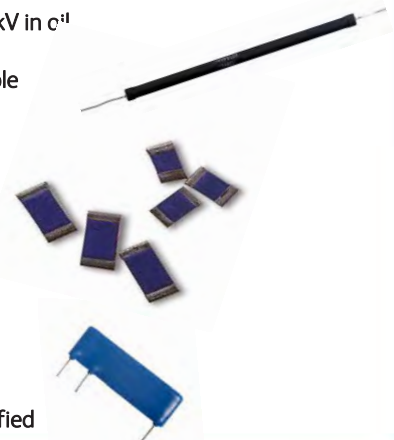

Application Note

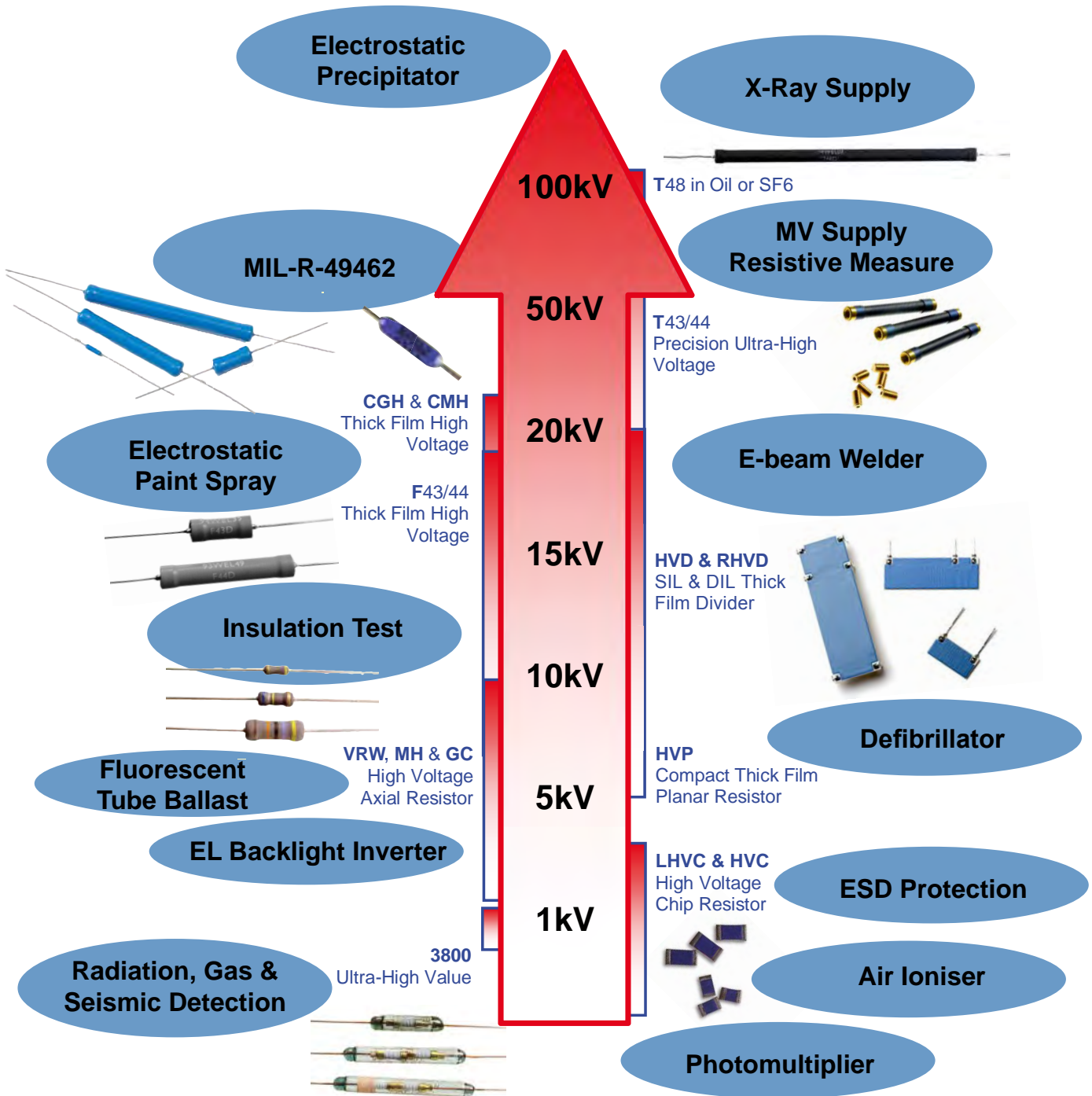

Application Note

High Voltage Product Selector

Voltage Range (kV)	Series	Description	Value Range	Datasheet
0.7 to 0.9	WPYP	Capacitor-mounted bleed resistors	1R to 120K	http://www.ttelectronics.com/sites/default/files/resistors-datasheets/WPYP.pdf
0.5 to 1	3810	Glass-sealed ultra-high value resistors	100M to 100T	http://www.ttelectronics.com/sites/default/files/resistors-datasheets/3810.pdf
0.2 to 2	LHVC	Lower range HV thick-film chip resistors	50K to 10M	http://www.ttelectronics.com/sites/default/files/resistors-datasheets/LHVC.pdf
1 to 3	HVC	HV thick-film SMD chip resistors	10K to 1G0	http://www.ttelectronics.com/sites/default/files/resistors-datasheets/HVC.pdf
1.6 to 3.5	MH	Axial ¼ and ½ W thin-film resistors	100K to 10M	http://www.ttelectronics.com/sites/default/files/resistors-datasheets/MH.pdf
1.6 to 10	VRW	Axial ¼ , ½ 1W thick-film resistors	100K to 68M	http://www.ttelectronics.com/sites/default/files/resistors-datasheets/VRW.pdf
1.7 to 10	GC	Axial ¼ and ½ and 1W thick-film resistors	47K to 1G	http://www.ttelectronics.com/sites/default/files/resistors-datasheets/GC.pdf
7.5 to 30	HVD	Thick-film high voltage SIL resistive divider	7K5 to 5G0	http://www.ttelectronics.com/sites/default/files/resistors-datasheets/HVD.pdf
0.75 to 20	CGH ¹	High voltage precision axial resistor	100K to 2G	http://www.ttelectronics.com/sites/default/files/resistors-datasheets/CGH.pdf
2 to 20	HVP	Thick-film compact high voltage SIL	1K to 1G5	http://www.ttelectronics.com/sites/default/files/resistors-datasheets/HVP.pdf
4 to 28	F	High voltage axial resistor	2M to 150G	http://www.ttelectronics.com/sites/default/files/resistors-datasheets/F.pdf
4 to 100	T	Ultra-high voltage precision axial resistor	1K to 50G	http://www.ttelectronics.com/sites/default/files/resistors-datasheets/T40.pdf

1. MIL-R-49462 approved version available as CMH

Maximum Voltage Plots for Selected Products

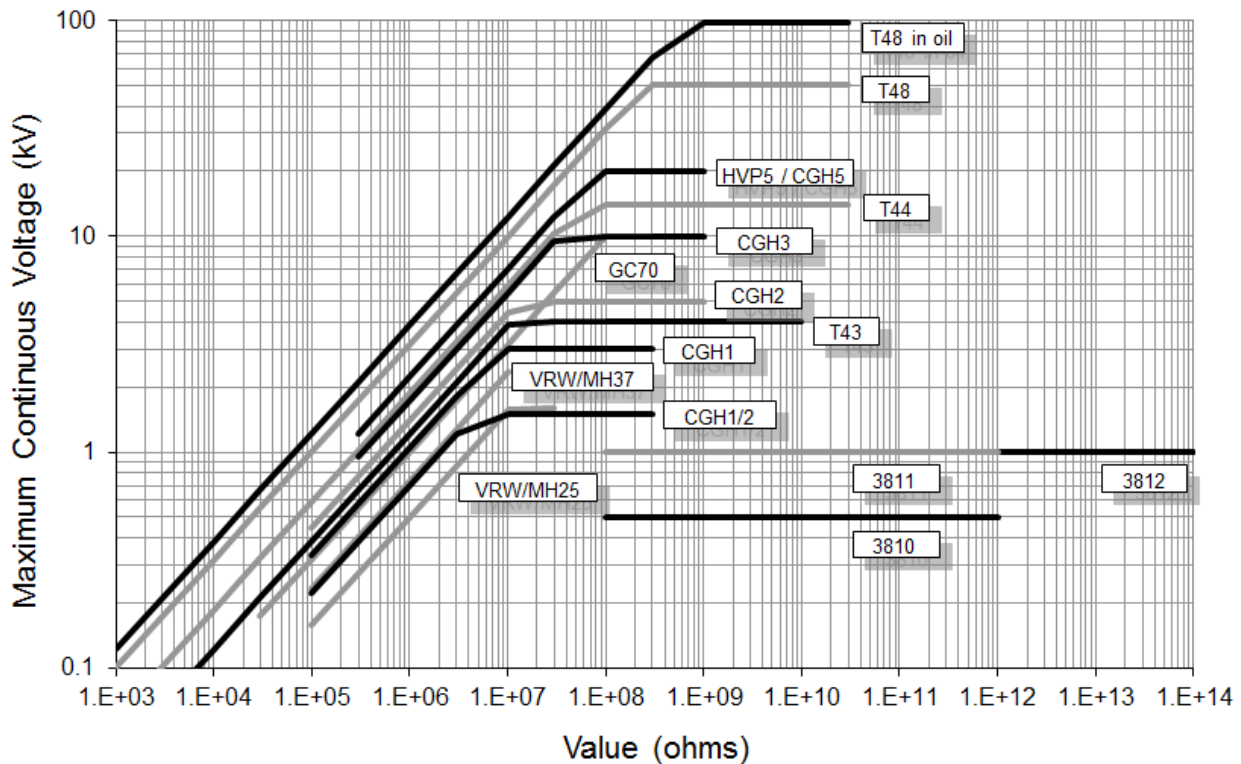

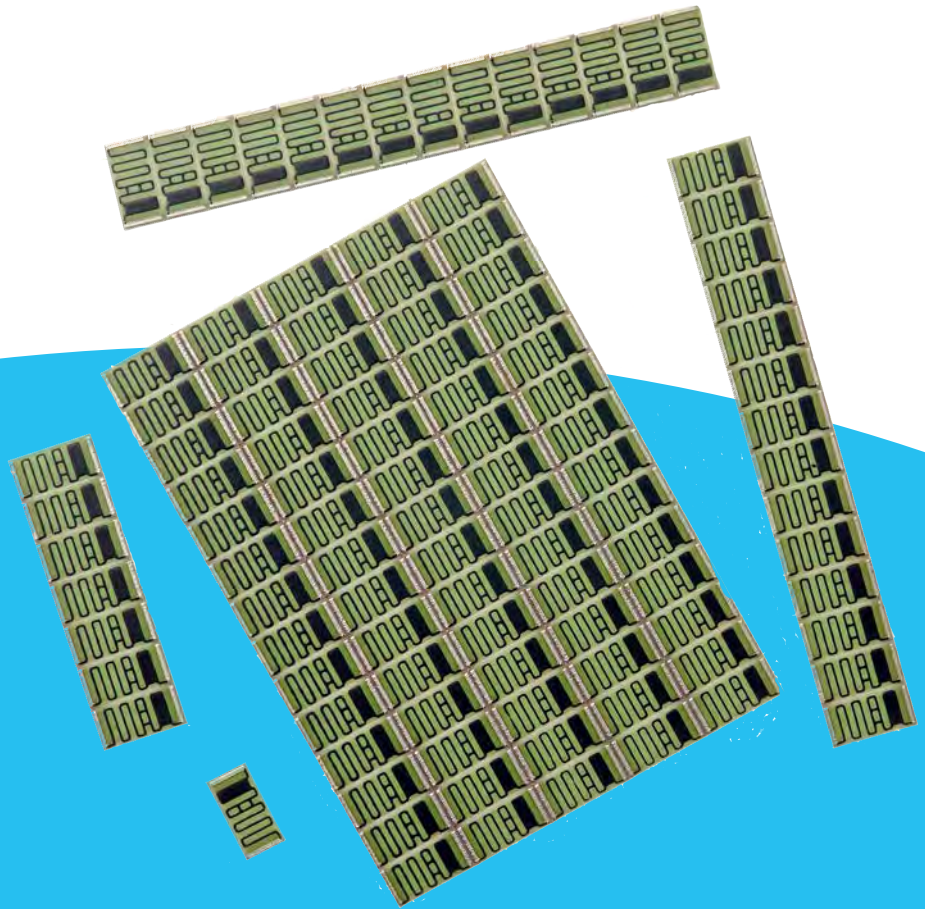

www.ttelectronics.com/resistors

TT Electronics, 4222 South Staples St., Corpus Christi, TX 78411, USA

TT Electronics, Welwyn Electronics Park, Bedlington, Northumberland, NE22 7AA, UK

General Note TT Electronics reserves the right to make changes in product specification without notice or liability. All information is subject to TT Electronics' own data and is considered accurate at time of going to print.